

INCLUDING
*Communication
 Engineering*
 and
*TV & Radio
 Engineering*

RADIO-ELECTRONIC *Engineering* SECTION

Reg. U. S. Pat. Off.

RADIO & TELEVISION NEWS

MAY, 1954

FREQUENCY SWEEPING TECHNIQUE
 FOR U.H.F.

-5-

ELECTROCALL—
 A SELECTIVE CALLING SYSTEM

-8-

PROTECTIVE RELAYING

-10-

HIGH TEMPERATURE STRAIN GAGES

-12-

WATER LOADS

-14-

ATTENUATING SPURIOUS FREQUENCIES

-16-

TRANSISTOR NEGATIVE
 RESISTANCE CHARACTERISTICS

-17-

OPTICAL-SENSING DEVICE
 FOR COMPUTERS

-20-

DEPARTMENTS

COMMUNICATION REVIEW -22-

NEW PRODUCTS -24-

NEW TUBES -26-

TECHNICAL BOOKS -28-

NEWS BRIEFS -30-

NEW LITERATURE -32-

TV-AM-FM PRODUCTION -32-

PERSONALS -34-

CALENDAR -46-

Copyright, 1954, by Ziff-Davis Publishing Company
 WILLIAM D. ZIFF (1898-1953) FOUNDER

RADIO-ELECTRONIC ENGINEERING is published each month as a special section with a limited number of copies of RADIO & TELEVISION NEWS, by the Ziff-Davis Publishing Company, 366 Madison Avenue, New York 17, N. Y.

Edited by H. S. RENNE

and the Radio & Television News Staff

Antenna test site for airborne radar being built by General Electric at Utica, N. Y., for the U. S. Navy, simulates installation in the aircraft. Antenna will be housed in bubble-like structure below fuselage.

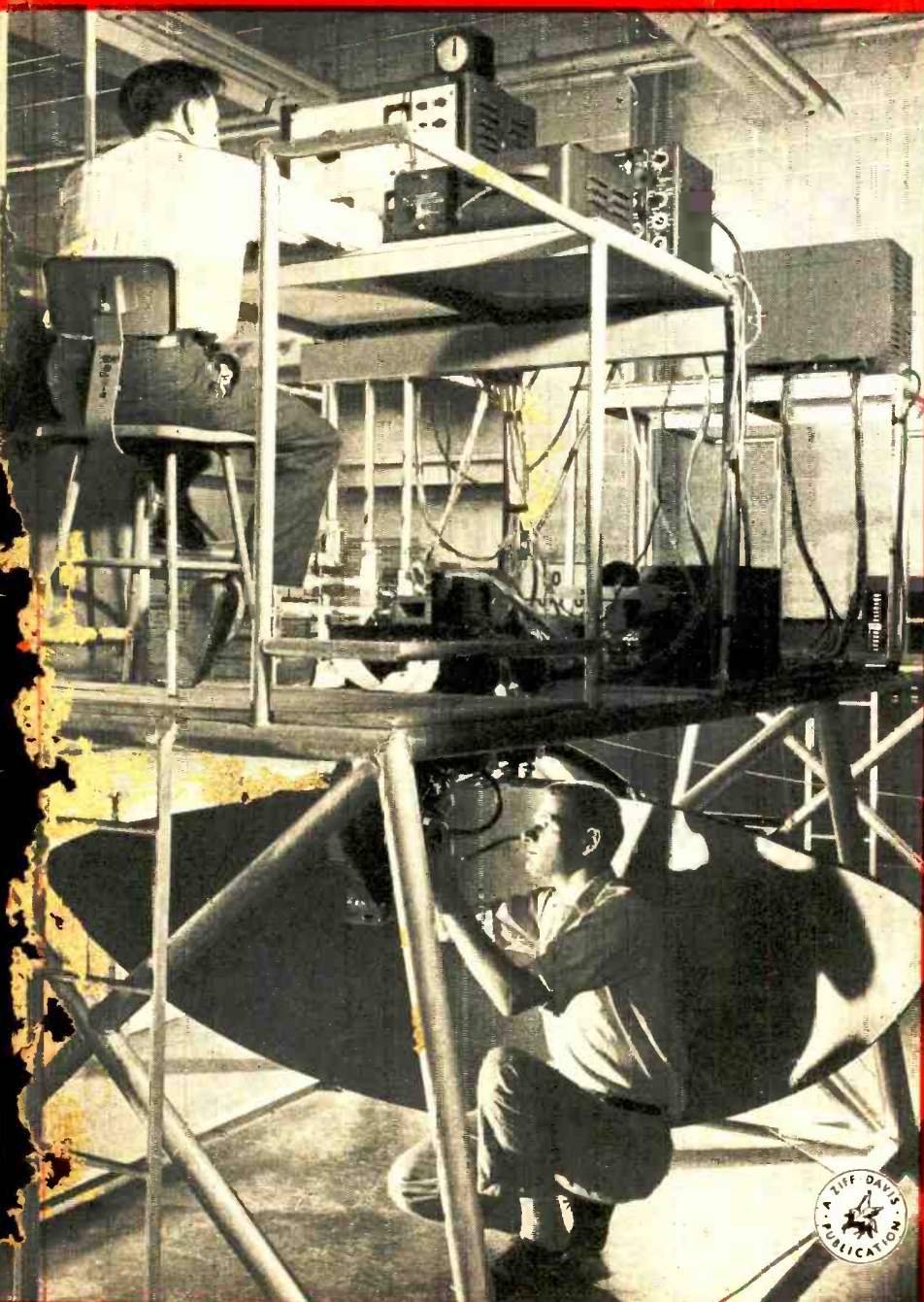

TELEVISION • ELECTRONICS • COMMUNICATIONS • AUDIO • MICROWAVES • RADAR • RESEARCH



Revolutionary LINEAR STANDARD AMPLIFIER

NEW HEIGHT OF FIDELITY
20 WATTS
KIT FORM



LINEAR STANDARD MLF AMPLIFIER

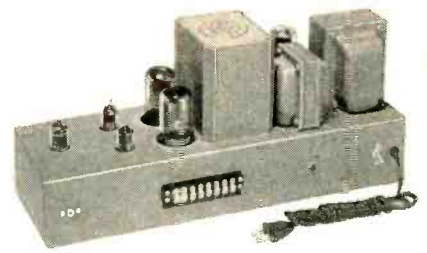

WITH COVER REMOVED

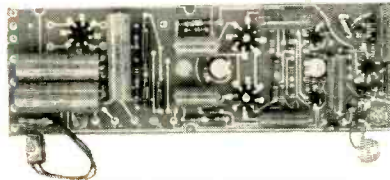

PRINTED CIRCUIT CONSTRUCTION



SUITED TO 7" RACK PANEL MOUNTING

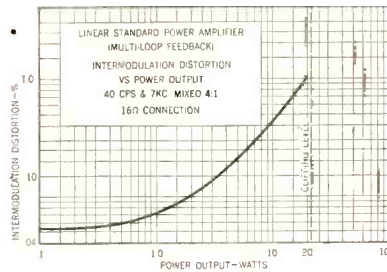

INTERMODULATION DISTORTION CURVE

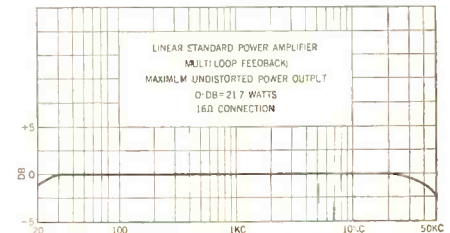

FREQUENCY RESPONSE CURVE

The Linear Standard amplifier climaxes a project assigned to our audio engineering group a year ago. The problem was, why does a Williamson circuit amplifier which tests beautifully in the laboratory seem to have considerable distortion in actual use? It took a year to fully determine the nature and cause of these distortions and the positive corrective measures. This new amplifier not only provides for full frequency response over the audio range but, in addition, sets a new standard for minimum transient distortion.

An inherent weakness of the Williamson circuit lies in the fact that its negative feedback becomes positive at subsonic frequencies. The resultant instability in use lends to parasitic oscillation at the high end and large subaudio cone excursions both of which produce substantial distortions. The Linear Standard Amplifier uses Multiple Loop Feedback and network stabilization to completely eliminate these instabilities. The oscillograms below show comparative performance. The flat frequency response and extremely low intermodulation distortion provided by 36 db feedback, are self evident from the curves shown.

In addition to providing an ideal amplifier electrically, considerable thought was given to its physical form. A number of points were considered extremely important: (1) Size should be minimum (power and audio on one chassis). (2) Each kit must have identical characteristics to lab model. (3) Rugged, reliable, structure is essential.

This resulted in a rather unique construction employing a printed circuit panel as large as the chassis with virtually all components pre-assembled and wired. The result is that each kit, which comes complete, including tubes and cover, can be fully pretested before shipment. Additional wiring involves only the connection of 17 leads to screw terminals for completion.

LINEAR STANDARD TYPE MLF AMPLIFIER SPECIFICATIONS...

Rated Power Output:	20 Watts
Intermodulation Distortion:	.07% -1W, 1% -20W
Frequency Response (controlled):	1 db 20 to 20,000 cycles
Hum & Noise Level:	80 db below rated output
Feedback:	36 db
Output impedances (not critical):	4, 8, 16 also 2, 5, 10, 20, 30 ohms
Tubes:	1-12X7, 2-6AU6, 2-5881, 1-5V4G
Dimensions & Weight:	5 1/4" x 8" x 17 1/8", 24 lbs.
Net Price:	\$108.00

COMPARATIVE PERFORMANCE

LINEAR STANDARD

WILLIAMSON TYPE

Step function
(low frequency)
transient stability.

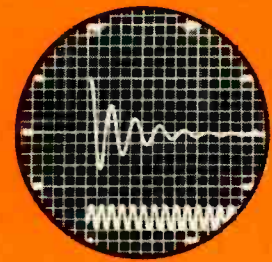
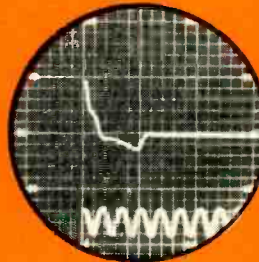

High frequency
oscillation stability.
Average speaker wiring
capacity.

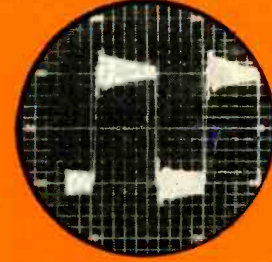
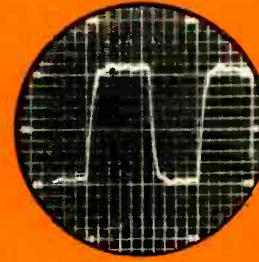

Overload recovery
transients.

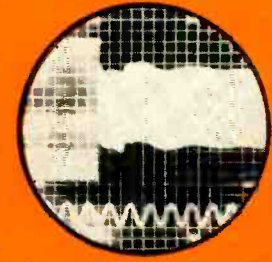
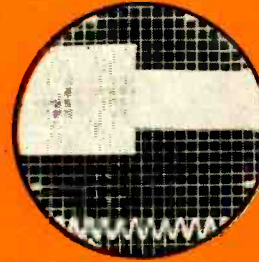

United Transformer Co.

150 VARICK STREET NEW YORK 13, N. Y.
EXPORT DIVISION, 13 EAST 40th STREET, NEW YORK 16, N. Y. CABLES: VARLAB

New circuit development obsoletes conventional UHF 2-Way Radio design

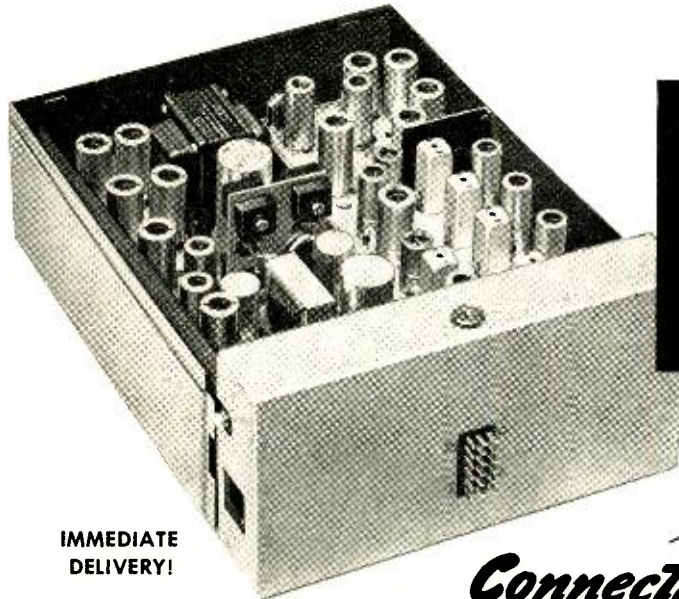

IMMEDIATE DELIVERY!

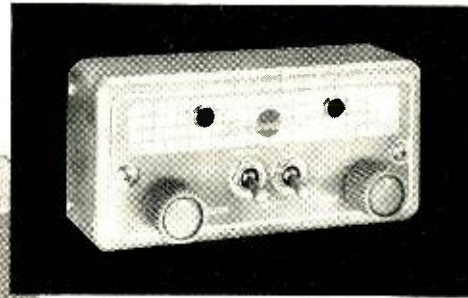

Connecticut **FLEETWAY** FIRST FM 2-WAY RADIO

UNIQUE CONN-TENNA DESIGN BEAMS STRONG HORIZONTAL SIGNAL

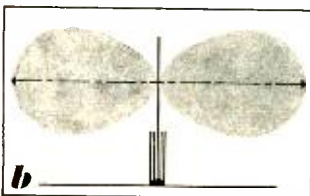
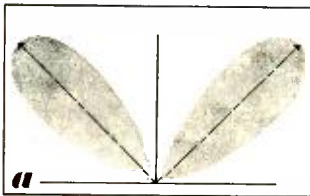

More evidence of FLEETWAY's radical design is found in its new Conn-tenna. Sketch A shows how conventional monopole antenna dissipates much of its signal at 45° upward angle. Sketch B shows how multipole Conn-tenna concentrates radiation along a horizontal plane, transmitting a stronger signal with lower power requirement.

HIGHER OVERTONE • The patented Lister circuit uses a starting frequency of 75 Mc instead of the usual 6 Mc. Low 6-time frequency multiplication required to reach 450 Mc contrasts with 24-times or more in other types of equipment.

GREATER STABILITY • Direct circuitry and fewer components permit better control of signal output, greatly minimize drift and spurious radiation. Result is greater stability requiring minimum maintenance, producing clearest signal ever attained in mobile radio.

'FM' CLARITY MINUS NOISE • True frequency modulation — for the first time in mobile radio — produces noise-free, natural tone quality, and eliminates distortion so common in conventional equipment. *This is true FM, not commonly used phase modulation (PM).*

LOWER OPERATING COST • Simplified FLEETWAY circuitry requires fewer tubes and parts — uses standard, lower cost crystals and tubes, needs less servicing.

NEW 450-470 Mc BAND OPENS 2-WAY RADIO TO EVERY CITIZEN AND COMPANY • Even if you have not been able to obtain a license for 2-way radio for yourself or your business, the chances are you can now get an immediate assignment in the recently opened 450-460 commercial fleet band or in the 460-470 citizens' band. These new bands offer easy licensing requirements for anyone who does not qualify in one of the older channels. You can now enjoy the advantages of FLEETWAY mobile radio for business or private use.

See your local FLEETWAY dealer or write for "Technical Comparison" booklet containing parts and performance comparison of leading mobile radio equipment.

Connecticut

CONNECTICUT TELEPHONE & ELECTRIC CORP.

98 BRITANNIA ST.

MERIDEN, CONN.

Announcing another outstanding
DESIGN ACHIEVEMENT by *Federal*

S·C·S
 "SINGLE-CRYSTAL-STABILIZED"

GERMANIUM
DIODES

Available in
 these 14 types:

IN34	IN55
IN38	IN56
IN39	IN58
IN48A	IN63A
IN51A	IN64A
IN52A	IN65A
IN54	IN75A

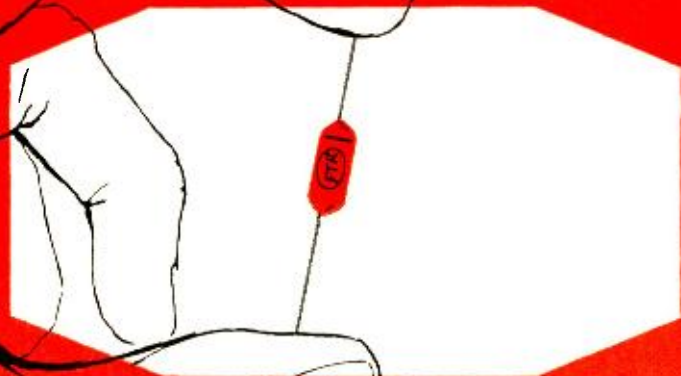

CHECK THESE FEATURES—

- SINGLE-CRYSTAL GERMANIUM**—the finest for reliable performance
- MOISTURE-PROOF**—vacuum-sealed, all-ceramic construction to provide stable characteristics
- EVERY DIODE TESTED** for all characteristics, including oscilloscope tests for hysteresis and non-linearity
- COMPLETELY INSULATED CASE**
- POLARITY** clearly identified
- HEAT SINKS** protect during soldering
- SMALL SIZE** ($-\frac{1}{4}$ " diameter, $\frac{1}{2}$ " long)
- FLEXIBLE LEADS** for easy mounting
- NO FILAMENT**—no heater power drain or hum
- LOW SHUNT CAPACITY** (average 1 mmf.)
- SELF-HEALING** for temporary overloads
- NO CONTACT POTENTIAL**
- WITHSTANDS** adverse temperature and humidity cycling

"SINGLE-CRYSTAL-STABILIZED"

... precision-made and vacuum-sealed to provide a new high in performance for germanium diode applications!

Product designers! Now it's Federal's new *single-crystal-stabilized* diodes . . . bringing to you high-quality single-crystal germanium for the utmost in reliable performance, combined with a construction to provide stable operation over long hours of use.

Federal "S-C-S" Diodes are vacuum-sealed . . . solidly encased in a non-porous ceramic that firmly bonds both ends to case and leads, resulting in *moisture-proof* construction.

Federal "S-C-S" Diodes withstand repeated temperature and humidity cycling—without adverse effect on their electrical characteristics. Their small size, fully insulated case and flexible leads permit fast, easy mounting in all types of equipment.

Get all the facts about Federal "S-C-S" Diodes . . . a notable contribution to diode progress . . . insuring tens of thousands of hours of dependable performance!



Federal Telephone and Radio Company

SELENIUM-INTELIN DEPARTMENT

100 KINGSLAND ROAD, CLIFTON, N. J.

In Canada: Federal Electric Manufacturing Company, Ltd., Montreal, P. Q.
 Export Distributors: International Standard Electric Corp., 67 Broad St., N. Y.

For details on Federal "S-C-S" Diodes, write to Dept. R-159

FREQUENCY SWEEPING TECHNIQUE FOR U. H. F.

By

WALTER H. BUCHSBAUM

Kollsman Instrument Company*

CONVENTIONAL methods of measurement in the u.h.f. band make use of a single frequency generator, a detector and an indicating device; a great number of readings are required in order to determine various characteristics as they apply over the frequency band. It is quite apparent that this point-by-point technique is both time-consuming and inefficient because it does not permit the operator to observe immediately the effect of any adjustments he might make. In television v.h.f. and i.f. alignment, a sweep frequency signal generator is used in connection with a detector and oscilloscope to display the actual frequency response curve directly on the oscilloscope, thereby permitting the operator to make necessary adjustments and observe their effect instantly. For work in the u.h.f. band, it is expeditious to extend the techniques used for the v.h.f. and i.f. alignment of television receivers.

This article deals with an improved technique for measuring, observing and recording all major characteristics of such devices as u.h.f. tuners, filters, transmission lines, matching networks, antennas, etc. The following measurements can be made: bandpass and frequency response, standing wave ratio, and attenuation. Although this technique was developed primarily for u.h.f. TV tuner research and employs some specially designed test equipment, commercially available u.h.f. sweep generators and accessories can also be used. Several complex developments in the microwave region have utilized methods similar to that described here.

Bandpass and Frequency Response

The major characteristics of any

*Wholly owned subsidiary of Standard Coil Products Company Inc.

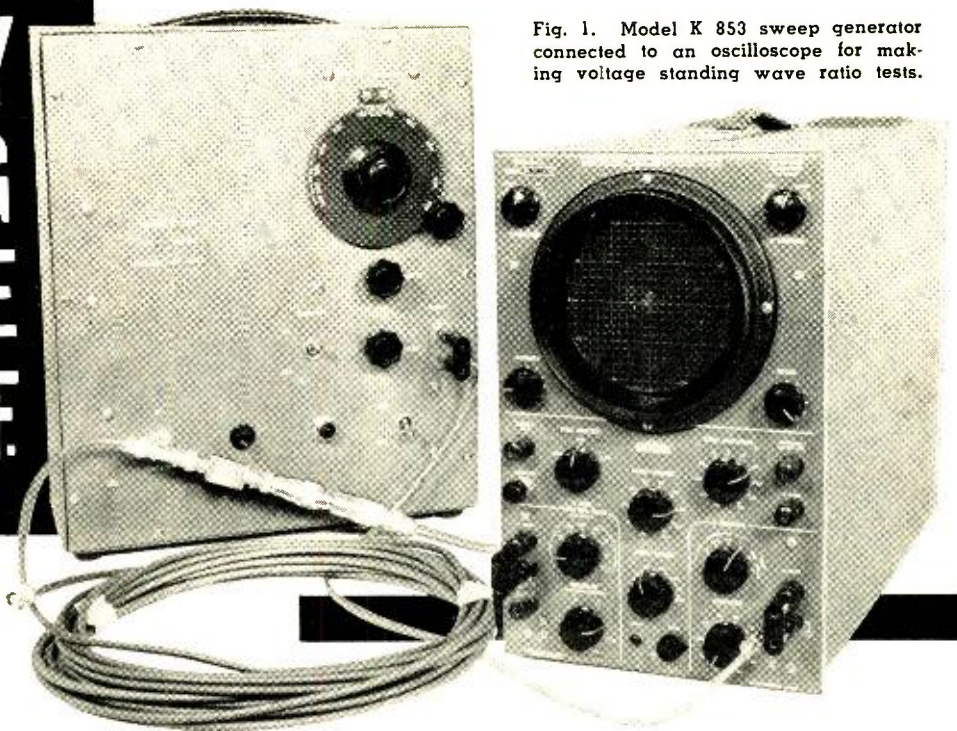

Fig. 1. Model K 853 sweep generator connected to an oscilloscope for making voltage standing wave ratio tests.

Sweeping the entire u.h.f. band provides valuable information in u.h.f. tuner and circuit design.

resonant network are its frequency response and the width of the passband. The bandpass is the determining factor in the sweep width requirement for the sweep frequency generator. If the bandpass is 10 mc., at least 20 to 30 mc. sweep width must be available to observe the response curve completely. If it is desired to check sidebands, unwanted responses, etc., an even wider sweep width is advantageous. For television tuners, it was found that the optimum sweep width is at least three times the bandpass response. In the research and development phase, the final bandwidth is usually not known and it is desirable to have a generator which covers the entire u.h.f. television band in one sweep and at a 60-cycle repetition rate. Shown in Fig. 1 is a wide-band sweep generator which has been developed to accomplish this purpose. All measurements and observations listed below have been made

with this wide-band sweep generator. However, comparable results have been obtained with a narrow-band sweep generator having a tunable center frequency and covering the u.h.f. TV band in steps.

The main advantage of using a wide-band sweep generator is that the tuner can be tested over the entire band without having to reset the sweep generator center frequency. Connections shown in Fig. 4 are used to observe frequency response. These connections give pictures as shown in Figs. 2A and 2B, where the complete set of frequency responses of the tuner over the entire u.h.f. TV band is visible and the variations in tracking and alignment can be observed as the tuner is switched over the band.

So that specific frequencies may be determined, the wide-band sweep generator shown here contains a high Q cavity absorption-type marker. The ac-

Fig. 2. Tuner response for (A) channels 14, 20, 30 and 40, (B) channels 50, 60, 70 and 80. (C) channel 50 with expanded sweep.

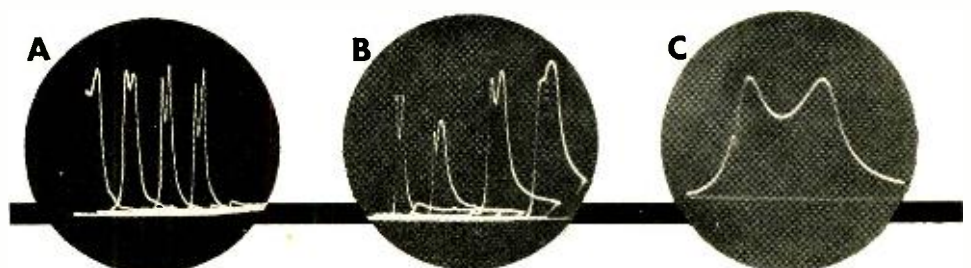

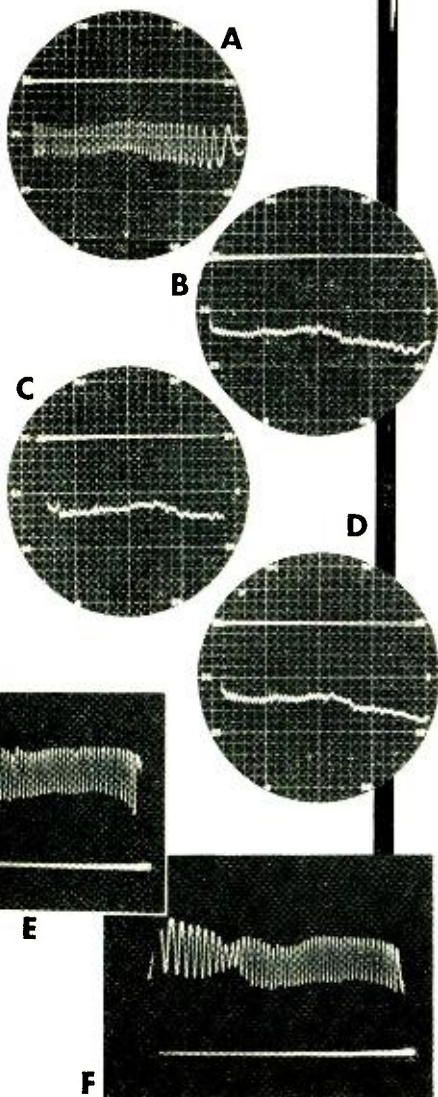

Fig. 3. Sweep frequency responses using 35 feet of RG-55/U cable (A) unterminated; terminated with (B) 50-ohm load. (C) 50-ohm, 20-dB attenuator. (D) a balun which is in turn terminated in 300 ohms, (E) unterminated balun, and (F) balun and tuner on channel 70.

curacy of this marker is ± 1.5 mc. over the band. In Figs. 2A and 2B, the marker is visible at the various response curves, providing a double check as to the correct tuning frequency of the tuner itself. A more complex setup, suitable for production testing, would utilize a chain of absorption-type markers preset at discrete frequencies and thus providing a continuous, accurate, stable frequency marking over the u.h.f. TV band.

As may be seen in Figs. 2A and 2B, the transfer characteristic of the bandpass network in this u.h.f. tuner changes somewhere in the higher band. This change is indicated by the loss in amplitude and is further shown by unequal peaks, overemphasis on one sideband response, and—eventually—overemphasis on one peak. If the tuner

tracking were now adjusted at the high frequency side and the tuner then tuned over the band again, the effect of this adjustment on the low frequency portion would immediately become apparent. In other words, the response of the tuner can be optimized by simply adjusting the tuner alone.

Note that the unwanted image response, approximately 30 db down, is clearly visible in the composite photographs of Figs. 2A and 2B, and it is possible to check the frequency at the maximum image response amplitude.

In addition to observing the bandpass characteristic of a u.h.f. network, the arrangement shown in Fig. 4 also lends itself to over-all gain measurements in u.h.f.-v.h.f. sections. By using a calibrated attenuator in series with the r.f. output of the sweep generator, it is possible to measure relative gain through u.h.f., v.h.f., and even the i.f. section of the receiver. The bandpass response on the oscilloscope in this instance will be that of the narrowest rather than the widest band, i.e., the video i.f. section will appear as a very narrow spike. By increasing the gain of the horizontal oscilloscope amplifier, it is possible to observe even a narrow 4-mc. band. The effect of expansion of the horizontal sweep is best shown in the photograph of Fig. 2C, where channel 50 (shown also in Fig. 2B) has been expanded to fill the entire oscilloscope screen. The marker pip is clearly visible in this picture.

Because of space limitations, only a few of the many bandpass measurements possible with the sweep frequency technique can be discussed. One important use is that of matching the network input impedance to the sweep frequency generator. In the wide-band sweep generator illustrated here, a 50 Ω coaxial output impedance is used and is transformed to a 300 Ω balanced system through a specially developed u.h.f. TV balun. Another aspect of tuner development work which can be checked is the loading effect caused by the crystal mixer for various amounts of oscillator injection voltage. By leaving the oscillator on and measuring crystal current while the response curve is aligned, the effects of oscillator injection voltage on the bandpass can be observed. Still another application of the wide-band sweeping technique is that of testing the performance of mixer crystals. A test circuit corresponding to the r.f. network in the tuner is connected to the sweep frequency generator, and observation of the resulting scope pattern allows crystals to be compared to a predetermined standard.

VSWR Measurements

For purposes of impedance matching, two different measurement techniques are currently in use. One makes use of the u.h.f. admittance bridge while the other employs a slotted line for long line measurements. In both cases, all measurements are taken at discrete frequencies, and thus must be plotted before the impedance characteristic of a certain network is known over its operational band. A further drawback of both of these methods is that they are more suitable for 50 Ω coaxial systems than for the 300 Ω balanced systems commonly used in u.h.f. television tuners. The wide-band sweeping technique, as outlined below, is usable with any impedance and allows instant observation of the impedance characteristic of the entire band.

The block diagram of Fig. 5 shows the connections used for a typical 50 Ω long line test setup. The detector detects the direct output of the sweep generator and also the reflections from the long line. Since the reflection amplitude is a direct function of the termination of this long line, it is possible to calibrate the resulting display so as to show standing wave ratio—or impedance mismatch—over the frequency band. It is necessary that the transmission line used here be long enough to provide sufficient reflections for a close observation of the band. For work in the u.h.f. television band, about 35 to 50 feet of transmission line provides enough reflections for approximately 10-mc. separation between peaks. Figure 3A shows an oscilloscope pattern resulting from the test setup of Fig. 5 when no termination is used for the 50 Ω long line. Figure 3B shows the result of terminating the long line in a *General Radio* 874 WM 50 Ω coaxial termination. Note that the amplitude of the reflections is greatly decreased. Replacing the 50 Ω termination with a homemade 20-dB attenuator and terminating this attenuator with the 50 Ω load results in the VSWR of the homemade attenuator shown in Fig. 3C. Any number of 50 Ω devices can be checked in a similar manner.

To check efficiency of a 50 Ω to 300 Ω balun, the 50 Ω side of this device is connected to the load end of the line. With the 300 Ω end unterminated, the response shown in Fig. 3E is obtained. When a good 300 Ω termination is connected to the balun, the response shown in Fig. 3D results. To observe the impedance match of a typical u.h.f. TV tuner at 300 Ω , the input network of the tuner should be connected to the 300 Ω terminal of the balun. Figure 3F shows that a semblance of impedance match is obtained at one frequency. This frequency is 810 mc., the tuner being tuned to channel 70.

Figures 3D, 3E and 3F permit a qualitative analysis of VSWR but do not represent accurate measurements. By calibrating the amplitude of reflections against known values of VSWR, however, it is possible to measure the actual standing wave ratio at certain frequencies within an accuracy of about 10%. The amount of attenuation due to the long transmission line will control to some extent the sensitivity of this type of measurement and, if a minimum attenuation transmission line is used, a considerably greater accuracy will result.

When 300Ω impedances are to be checked, it is desirable to use a 300Ω transmission line. The block diagram of Fig. 7 shows a typical 300Ω test setup. In order to obtain a 300Ω source impedance, it was found convenient to insert two 150Ω resistors in series with the balun and to construct a 600Ω balanced detector. The parallel combination of the 600Ω impedances results in a good 300Ω source. As long line, the author has used 35 feet of tubular twin lead transmission line. Flat 300Ω transmission line was found to have excessive attenuation in the u.h.f. television band. It was also necessary to install the transmission line in a large loop, insulated from ground at all points, to avoid losses due to coupling between loops of transmission line. Figure 6A shows the oscilloscope pattern obtained when the 300Ω line is not terminated, while Fig. 6B shows the resulting pattern when a good 300Ω termination is used. Actual VSWR values of this termination, measured on a 300Ω balanced line, ranged from 1.05:1 to 1.13:1.

When a tuner having the bandpass responses shown previously in Fig. 4 is connected to the load of the 300Ω transmission line, a pattern like the one shown in Fig. 6C appears. In this picture, the tuner is set for channel 50 and it is quite apparent that at that channel the tuner does present approximately 300Ω.

The 300Ω long line test setup is also very useful in the testing of such devices as baluns, 300Ω detectors, 300Ω attenuators, etc. With the technique outlined here, it is possible to observe at once the VSWR and, therefore, the characteristic impedance of the particular device over the entire u.h.f. television band. To the engineer who has had to develop u.h.f. components by using the point-to-point measurement technique, the value of the wide-band sweeping technique will become quite apparent.

Attenuation Measurements

The wide-band sweeping technique is also advantageous in the measurement of attenuation. One example is a cross-

over network which separates the v.h.f. and u.h.f. signals for the respective tuner inputs. It is often desired to check the amount of the insertion loss of such a network in the u.h.f. TV band. This can be done by comparing the response curve obtained with a 50Ω detector directly at the output of the generator with the amplitude of the response obtained with the network in the circuit. Since the crystal diode used as the detector is not a linear device, it is only safe to measure voltages within 6 db and to compare the voltage ratios of the output with and without the network under test.

Another application is in checking the attenuation characteristic of transmission lines. Figures 6D and 6E show this type of measurement. In Fig. 6D, the detected output is shown to have an amplitude of approximately 13 divisions at the frequency of the marker, 800 mc. When 35 feet of RG-55/U is connected between the generator output and the detector, there are seven divisions at the marker frequency, as in Fig. 6E. This corresponds to an attenuation of approximately 5.5 db. The specifications for RG-55/U call for approximately 15-db attenuation per 100 feet at 800 mc. Therefore, a 35-foot length might be expected to have approximately 5.5-db attenuation, as shown in Figs. 6D and 6E. Another example of how the wide-band sweep technique can be used for checking attenuators is shown in the composite photograph of Fig. 6F. Illustrated here is the output amplitude without any attenuator (top curve), with a 6-db attenuator, and finally with a 10-db attenuator of calibrated values. Figure 6F clearly shows that both attenuators have constant attenuation over the band.

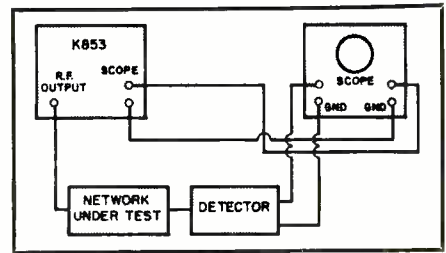

Fig. 4. Block diagram of setup for sweep frequency response test.

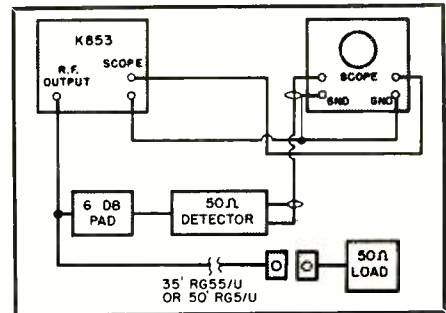
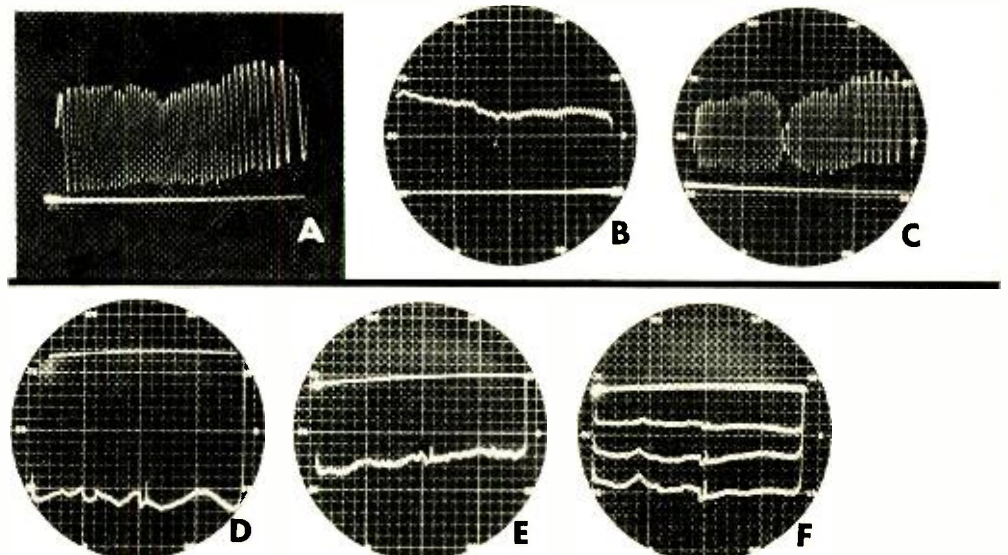

Fig. 5. Block diagram of the 50-ohm VSWR sweep frequency setup.

For the measurement of larger attenuation values, a modification of the above method can be used. Since the detected r.f. signal must normally be at least 0.1 volt peak in order to present a usable pattern, an oscilloscope preamplifier may be used. The presentation obtained with the attenuator under test and the subsequent preamplifier is compared in amplitude against a calibrated attenuator or a series of standard value attenuators. Thus, it is possible to measure up to 60 or 70 db of attenuation and to check the frequency response of these attenuating networks.

(Continued on page -46-)

Fig. 6. Responses obtained using 35 feet of 300-ohm line (A) unterminated, (B) terminated in 300 ohms, (C) terminated with tuner on channel 70. (D) 50-ohm detected output. (E) 35 feet of RG-55/U detected output. (F) Composite of 0-, 6- and 10-db attenuation.



ELECTROCALL-

A SELECTIVE CALLING SYSTEM

By **LAURENCE MOORE**

Lectrolab Manufacturing Company

Transmitted audio tones, accurately controlled in frequency and duration, control the receivers.

EVERYONE connected with radio communication is familiar with the problems of interference created by increased use of the necessarily limited radio frequency spectrum. Indeed, the usefulness of some channels is threatened in many areas by the growing use of radio communication for such services as taxicabs, intercity trucks and buses, auto emergency and motor delivery, petroleum and pipeline, police and fire protection. The basic solution to the problems of interference in shared use of radio channels depends upon the development of more efficient means of transmitting information over a limited band of frequencies. However, for the above types of services, most of the evils of interference can be minimized or eliminated by some form of selective calling system.

In these services, radio is used primarily for some kind of dispatching, and communication is desired primarily between a central station and many mobile or subsidiary units. The mobile receiver must be on at all times communication may be desired, but no one mobile unit is actually in use more than a small portion of the time.

The receiver output is largely composed of:

1. Transmission within the fleet to which the radio belongs
 2. Interference from other fleets sharing the same band
 3. R.F. noise, man-made and natural
- Transmission within the fleet which is of no concern to the particular receiver will be lumped with the other undesirable reception as "chatter."

Because a.v.c. is used, and because of the inherent nature of most demodulation processes, the radio signal with the greatest field strength dominates a modern receiver; therefore, interference is

not usually troublesome while the base transmitter is on. However, to insure reliable reception in any location, a mobile receiver must be very sensitive; hence, even weak signals from remote radio stations or moderate noise are sufficient to give a full output when the receiver's own central station is not transmitting. A selective calling system which keeps the mobile receiver quiet until its associated central transmitter begins a message will overcome the troubles due to the most common types of interference—that from other fleets sharing the same r.f. band, and r.f. noise. However, it will not prevent interference caused by the presence of two or more signals in the same channel, all of practically equal strength.

The characteristic continuous chatter of present commercial fleet radio systems can be eliminated by selective calling which turns on the particular receiver for which the message is intended only when a message is directed to that receiver, and such chatter can be reduced to negligible proportions in most fleets by means of fleet or group calling

Fig. 2. Service area in sectors using two frequencies and directional antennas.

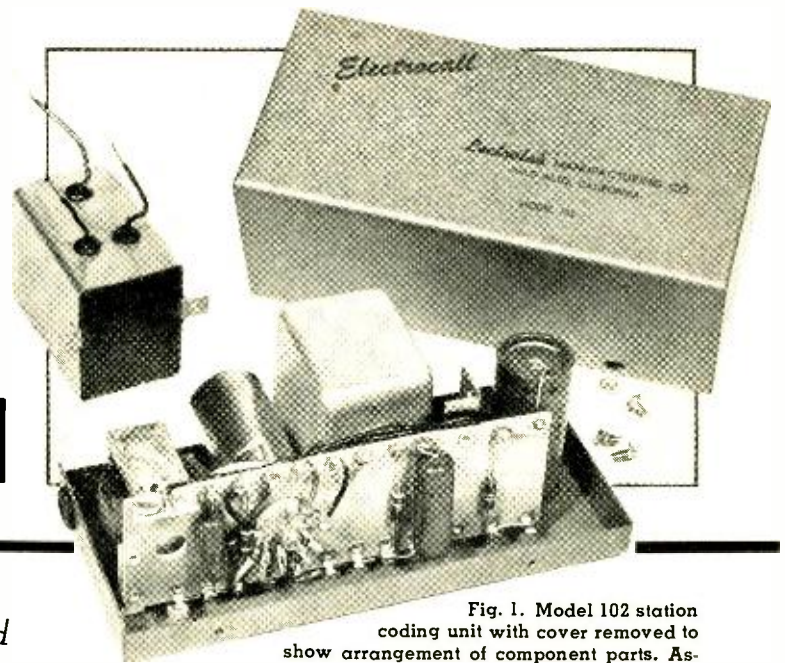
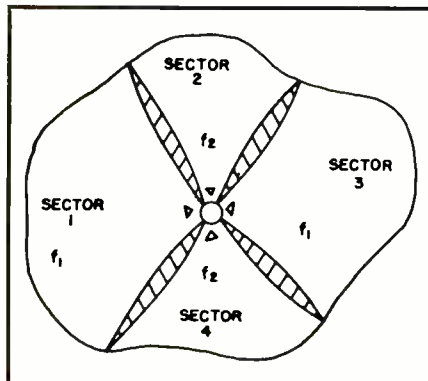

Fig. 1. Model 102 station coding unit with cover removed to show arrangement of component parts. Assembly at left is LC frequency-determining unit.

systems. Several types of calling systems have been used for many years, some with considerable success. However, the most reliable systems have been expensive, special-purpose systems not suitable for fleet use. Previous efforts to produce moderately priced systems have not been too successful in providing continued reliability in operation. Further, such few systems as are now available are either made for a particular radio or require considerable effort and special skill to install.

Three objectives were kept uppermost in the development of "Electrocall" selective calling systems:

1. Reliability of operation in almost any environment
2. Ease of installation and maintenance
3. Low cost

Additionally, the objective of universal application has been attained in that very minor alterations permit the use of standard units with any commercial radiotelephone equipment except walkie-talkie types. They may be used with either 6.3- or 12-volt mobile equipment. The low power requirement of Electrocall results in a decrease in the average battery drain of mobile receivers.

How Electrocall Works

An Electrocall system consists of a station coding unit which is attached to the transmitter and a receiver decoding unit attached to each receiver. Although the same principle is used both in selective calling models that permit calling each receiver individually and group call models which activate a group or whole fleet of receivers at one time, the two types of units are not identical. This article will describe an Electrocall group calling system—Models 102 and 103—in detail.

At the beginning of each transmis-

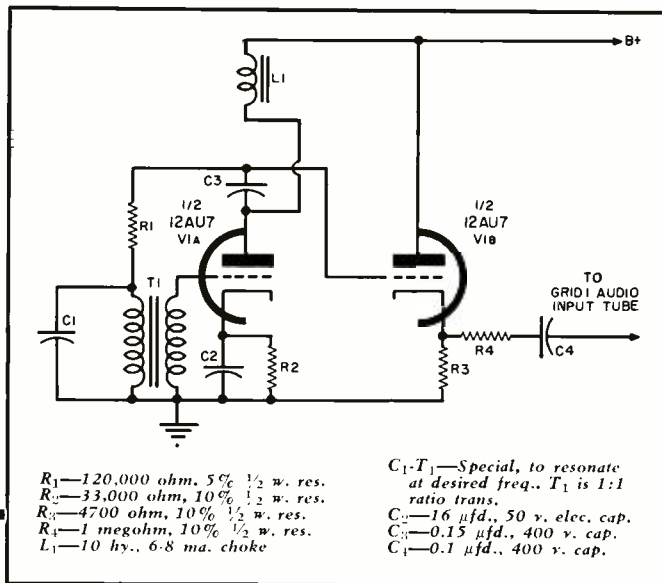

Fig. 3. Circuit diagram and representative parts list for Electrocall Model 102 station coding unit.

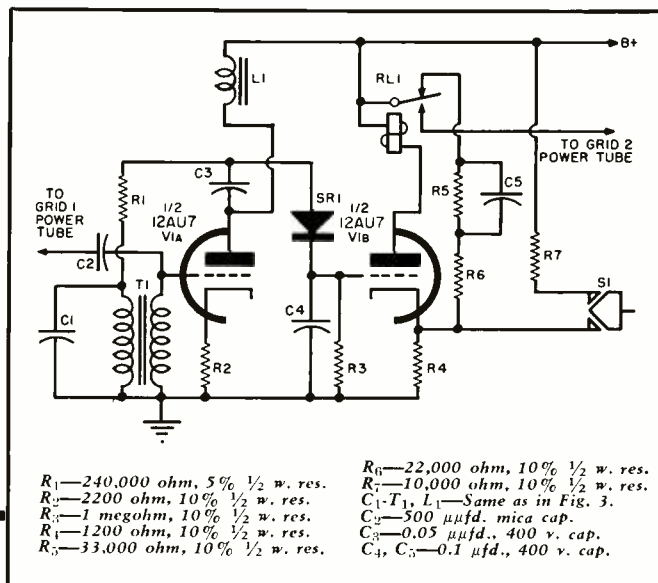

Fig. 4. Circuit diagram and representative parts list for the Model 103 receiver selector unit.

sion from the central station, the Model 102 unit causes an audio tone to be broadcast for a short period—less than one-half second. The Model 103 unit attached to the receiver holds the output stage of the receiver cut off until a sustained signal of the proper audio frequency is received. When such a signal is received, the Model 103 unit restores the output tube to its functioning condition and holds it there so that the receiver functions normally. At the end of a message, the receiver is restored to its cutoff condition either manually by means of a momentary action switch, or automatically when the transmitter of a two-way radio is used.

Figure 3 shows the circuit of the station coding unit. The oscillator is a resistance-stabilized LC tuned plate oscillator¹, cathode-coupled through a high impedance to the audio input stage of the station transmitter. Because of the unusual frequency stability of this circuit over a wide range of operating conditions, it is possible to control the duration of the audio pulse by means of a proper choice of circuit elements, i.e., oscillations start when the transmitter plate voltage is first applied, then cease after a controlled interval. The period of oscillations is determined by the magnitudes of L_1 , C_2 , the plate resistance of V_{1A} and the amount of feedback provided by R_1 across the impedance of the tuned circuit T_1 . Frequency of oscillation must be held to close limits, since the allowable drift determines the maximum selectivity that can be used in the receiver units.

Reliability is achieved in three ways:

1. A minimum of components is used.
2. The design is such that proper operation depends only upon the stability of T_1 , C_1 , i.e., there is only one critical component. T_1 is a high

quality inductor with very linear characteristics. C_1 is a large mica capacitor. After precise adjustment, T_1 and C_1 are potted with an epoxy resin which has excellent moisture- and temperature-resistance properties. (Fig. 1.).

3. All components used are conservatively rated; V_{1A} , V_{1B} is a 12AU7 miniature dual triode which can be expected to have a very long life in this service.

The 103 receiver selector unit, Fig. 5, is very similar to the 102 coding unit: T_1 , C_1 and V_{1A} , V_{1B} in Figs. 3 and 4 are

identical. The receiver selector circuit utilizes a combination of positive and negative feedback to provide a high, adjustable, and stable selectivity² from the LC circuit T_1C_1 . Its high sensitivity permits reliable operation without appreciable loading of the receiver. The output of V_{1A} is integrated by means of C_4 through a miniature rectifier. The time constant of C_4 and the effective resistance of the circuit are such that the frequency components found in normal voice transmission to which the unit is sensitive are not sufficiently

(Continued on page -36-)

Fig. 5. Model 103 receiver selector unit for fleet or group calling.

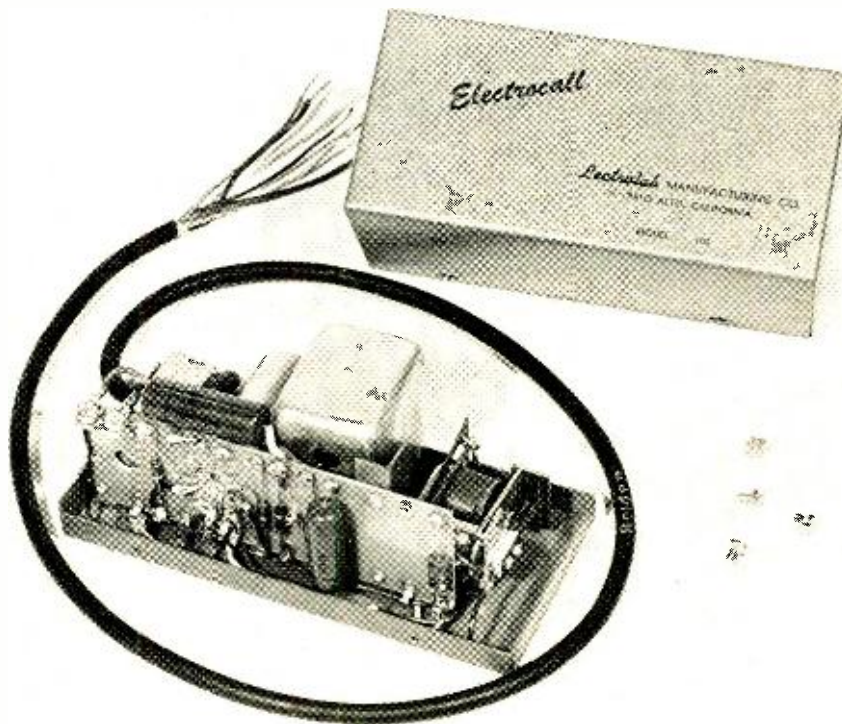

PROTECTIVE

Fig. 1. Carrier installation at one end terminal. The three units protect three separate lines.

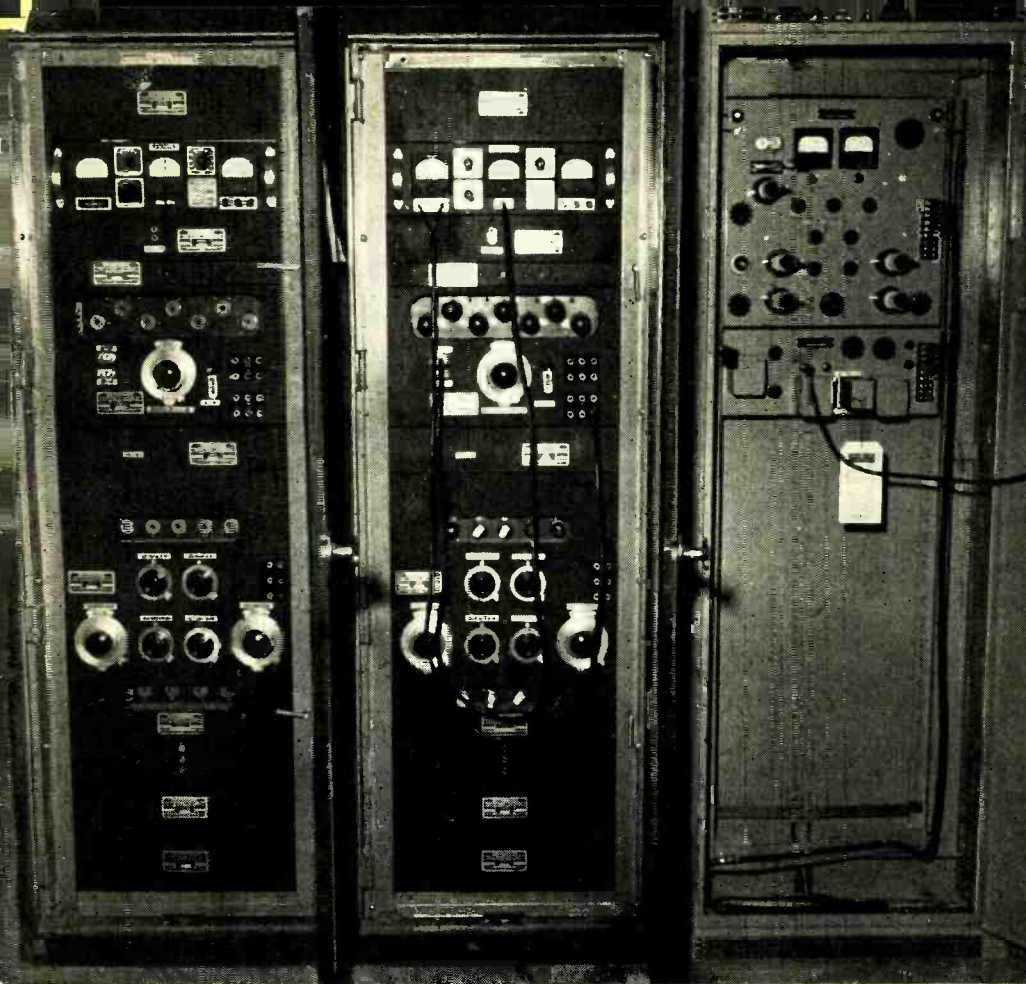

of a vacuum tube compares the phase position of the local sequence filter output with that of the far end. The polarities of the voltages are such that for internal faults plate current flows in the tube; on external faults, the grid is driven in the negative direction, cutting off plate current. A relay in the plate circuit of the vacuum tube closes the tripping circuit.

The basic electronic circuit of a phase-comparison control unit is shown in Fig. 5, while Fig. 1 shows a typical carrier installation. Generally, the operation may be explained as follows. Under fault conditions, the sequence network supplies an a.c. voltage to the thyatron grid circuit. The thyatrons conduct on alternate half-cycles, and perform two functions. One tube supplies d.c. plate voltage to the transmitter oscillator tube, initiating blocks of carrier at a 60-cycle repetition rate. This carrier is transmitted to the remote end, and a portion of the signal is also fed into the local receiver. The other thyatron supplies an operating voltage to the grid of the relay control tube. Detailed operation of the unit for both internal and external faults may be more clearly understood by referring to Figs. 4 and 6.

Filter output voltage is designated as A in Fig. 4 and is applied to the thyatrons through the saturation transformer; the operating voltage B is applied to a resistance network in the grid circuit of the relay tube, and is essentially a squared d.c. pulse. Progressing further, the carrier is transmitted in blocks as illustrated by C. The remote carrier is shown in phase at D. This condition occurs because the line currents are 180° out of phase during internal faults. The outputs of the sequence filters at both ends are now essentially in phase.

Rectified carrier E is applied to the grid in series with the operating voltage (Fig. 6). The net voltage on the grid is the sum of B and E, as shown in F. The reference level for F is the voltage E, required to cut off plate current of the

THE primary function of a protective scheme in a power system is to prevent or minimize any damage to transmission lines and auxiliary equipment during fault conditions. Faults usually occur through direct lightning strokes; however, other factors may contribute to the instability of the line and appear as faults. Early methods of protection consisted of relays that responded to voltage and current variations above or below defined limits. When the relays operated, tripping was initiated, and the circuit breakers opened the protected line section.

As power systems expanded, the necessity of clearing faults rapidly increased. Modern methods, employing power line carrier, have provided simultaneous high-speed tripping of breakers at both ends of a line within three cycles of the line frequency. Figure 2 illustrates how a transmission line is

divided into various protective zones.

Carrier relaying provides the link in which high-speed tripping circuits are literally "notified" of a fault. To determine whether an internal or external fault exists, i.e., a fault within or beyond the protected section, three-phase transmission line currents are utilized. These currents, obtained from current transformers, energize a sequence filter which delivers a single-phase output voltage that is proportional to a combination of the sequence components of a line current. Figure 3 displays a diagram of a sequence filter.

Under stable conditions, there is no output from the sequence filter. During faults, however, the single-phase output voltage controls an electronic circuit which allows carrier to be transmitted on alternate half-cycles of power frequency current. Carrier is transmitted from both end terminals. A grid circuit

Fig. 2. Block diagram showing how a typical transmission line may be sectionalized into protective zones.

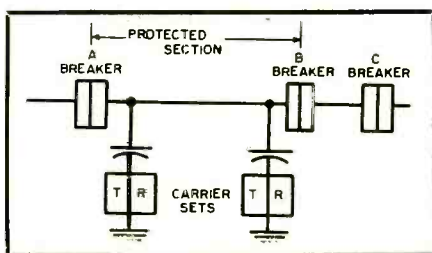
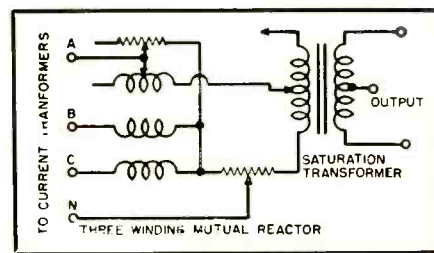

Fig. 3. Sequence filter network for deriving a single-phase output voltage from a three-phase input current.



RELAYING

By **NICHOLAS ALCHUK**

Phase-comparison system provides high-speed breaker tripping within three cycles of fault occurrence.

relay tube. Polarities are so arranged that there is no rectified carrier voltage during the half-cycle that the grid is positive because of the operating voltage. Consequently, plate current will flow on this half-cycle, as shown at G. The plate current is passed through an output transformer to remove the d.c. component H, and the secondary voltage is rectified and applied to the tripping relay. Relay current is depicted by I.

To review briefly, it is evident that the received carrier must be in phase with the local carrier. During the period when no carrier is received, the restraining voltage is removed from the relay tube. The operating voltage from the thyatron circuit drives the grid positive, causing the relay tube to conduct.

For external faults, heavy ground or phase currents may flow which will operate sensitive fault detector relays. Since it is not desirable to remove a sound line from service, means must be provided to block tripping. How this is accomplished may be seen by the aid of the waveforms for the external faults shown in Fig. 4.

On external faults, the carrier is transmitted on alternate half-cycles, as shown by C' and D'. E', the rectified carrier, provides a continuous negative restraining voltage. The actual voltage on the grid of the relay tube is shown at F', which is sufficient to cut off plate current and prevent the tripping relay from operating.

The line currents at the two ends will vary from 180° out-of-phase to in-phase. Blocks of received carrier will eventually widen until the waveform at E' is reached. Relay tube plate current will be blocked more and more over the operating cycle, and the current in the

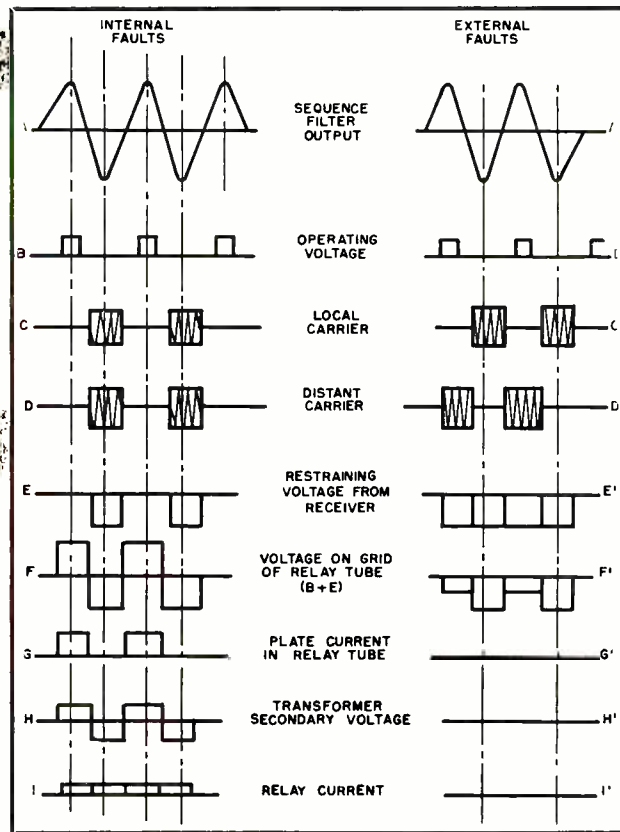

Fig. 4. Waveforms, operating currents and voltages occurring in control circuits during internal and external faults.

relay will follow the curve shown in Fig. 7. The 0° point represents an external fault, where the two end line currents are in phase. The relay can be set to operate over any angle of phase difference of the line current. As illustrated, one point is 60°. The amount of

tolerable spread depends upon transmission line stability.

Another function of carrier relaying is its extensive use with step-distance impedance relaying. The transmission line is protected by high speed relays
(Continued on page -42-)

Fig. 5. Typical control circuit for energizing or blocking tripping of the relay.

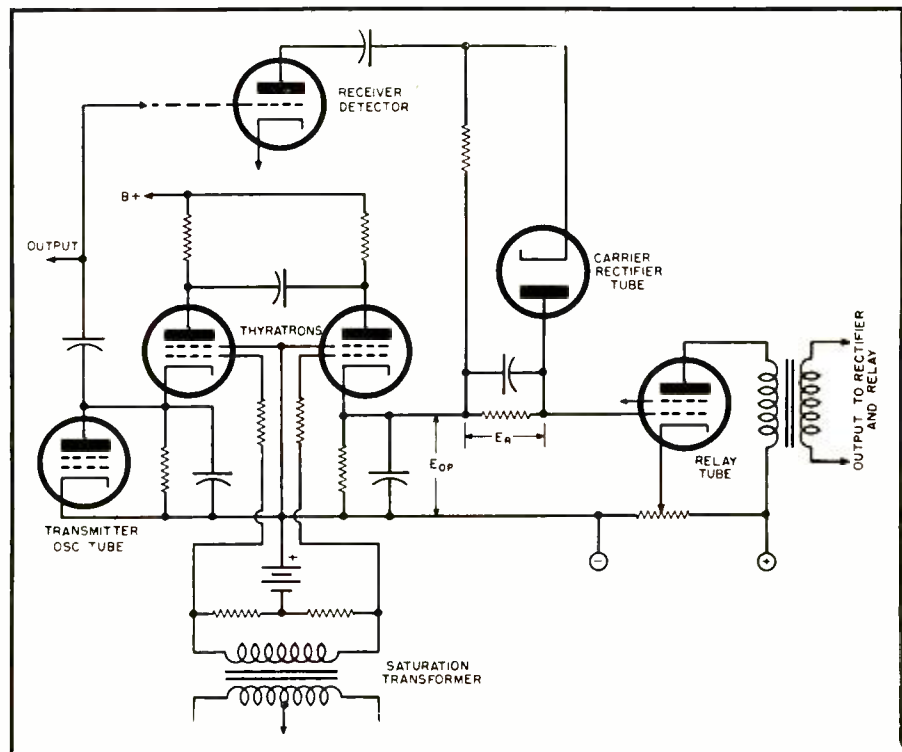

TRANS-SONICS, INC.
BEDFORD AIRPORT - BEDFORD, MASS.

Tel. 2508

TYPE 64-1
Surface Transferable High Temperature
Resistor

Active Resistance 123.7

Pat. applied for.

HIGH TEMPERATURE

By

ALVIN B. KAUFMAN

Research Engineer, Northrop Aircraft, Inc.

Fig. 1. A Trans-Sonic strain gage shown mounted (left and right) and before mounting on a surface (center).

APLICATION of strain gage instrumentation for the measurement of strain and stress, or as the active element for transducing deflection, pressures and other quantities into an electrical signal, has until recently been limited to an ambient range of temperature. The development of ceramic bonded strain gages has increased the usable operating temperature range to somewhat over 2000° F.

At present, two companies have high temperature strain gages commercially available. *Baldwin-Lima-Hamilton* is producing gages suitable for dynamic tests up to 1600° F, and is carrying on research to produce gages satisfactory for static and dynamic instrumentation up to 2000° F. *Trans-Sonics, Inc.*, meanwhile, is producing a line of gages with temperature limitations of 500°, 930° and 1012° F, respectively. The majority of information in this article is based on the *Trans-Sonic* ceramic bonded gages (Type 64 surface transferable resistors) which were investigated by the author.

Problems of possible shift in the gage factor with temperature, types of installation, and methods of electrical measurement were considered. An empirical test program was conducted which indicated the answers to many of these problems.

The signal output of a single *Trans-Sonic* gage was found to be in the same range as that of a *Baldwin* low temperature gage under the same strain condition, over the full range of operable temperature. The gage factor for the Type 64-2 is 2.25, which is slightly higher than that of standard strain gages. Other *Trans-Sonic* gages have a

gage factor of 1.95, approximating the general run of low temperature gages.

A stainless steel bending beam of 18-8 material was used for these tests, as shown in Fig. 5. The beam was wrapped with asbestos and heated by passing a high current at low potential through it. A single gage, Type 64-2, was installed. With a 1" deflection of the 24" beam, approximately a 1-millivolt output could be obtained, using a 6-volt bridge supply. The output and gage factor of the Type 64-2 were checked at 84° F and 1508° F, and within the limits of the measurement were unchanged at these two temperatures. As Fig. 4 indicates, the gage factor for Karma wire falls off about 9% at high temperature. In general, this variation of gage factor has not

been reported; it is of small enough magnitude to be ignored where extreme accuracy is not required.

The temperature coefficient of the 64-2 gage, although low (.000130), is sufficient to cause a radical change in its resistance as the temperature is varied. Changes of 10% to several hundred times the strain-induced resistance variation occur throughout the gage's temperature range due to temperature changes and the (dL gage/ dL base) effect. The gage wire temperature coefficient also approaches zero in the neighborhood of 1000° F and 1350° F. Therefore, when absolute strain or pressure measurements are required, a half-bridge configuration is needed to eliminate temperature-resistance and thermocouple effects. Unfortunately, many installations permit the application of but one gage, in which case it is practical to secure only dynamic information.

Gage Mounting

In general, it can be said that materials which oxidize rapidly at elevated temperatures will not support a satisfactory installation. As a result, the maximum temperature that a gage will withstand is usually limited by the base metal on which it is mounted or by the metal in the wire itself.

Type 64 surface transferable resistor strain gages are suitable for installation in the field on most metal surfaces. When installed, such a gage consists of a wire grid imbedded in a thin aluminum oxide layer and securely bonded to the metal surface. Total gage thickness averages 0.005". During shipment and storage, the wire grid is supported in a ceramic matrix, mounted on a thin paper card. To install the gage, a ceramic precoat layer is bonded to the surface to be investigated, after which the grid is transferred from the supporting card to the ceramic precoat. No organic

Fig. 2. (A) Circuit for two active gages marked "A" mounted on sides of a bending beam. (B) Different version for a tensile bridge. (C) Circuit for a carrier system.

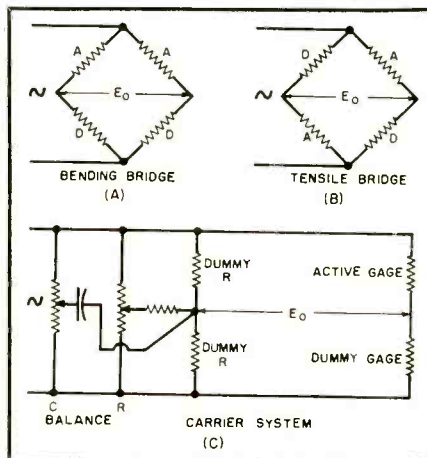

STRAIN GAGES

By use of ceramic bonding, properly designed strain gages may be operated at temperatures up to 2000°F.

material remains after the installation.

Table I shows the recommended maximum temperatures for various base materials. The ceramic layer is normally cured by first heating it to about 200° F until it is thoroughly dry; otherwise, the formation of steam bubbles may destroy the coating. Drying will ordinarily occur in a few minutes. The coating is then heated to 600° F for about five minutes. An infrared lamp will generally supply the desired heat.

When installing the gages on heat-treated metals and alloys such as duralumin (for example, 24ST), it may not be permissible to heat the specimen to 600° F. In this case, the ceramic may be cured at 375° F for five minutes; however, the gage should not be used above the maximum curing temperature. The curing time should be made sufficient to provide the desired insulation resistance between the gage and the base material.

During the initial run of the 930° and 2012° F gages at 900° F or higher, some leakage to ground may be observed for a short period; this is due to chemical action in the ceramic and will disappear within a few minutes.

The principal alloys in which *Trans-Sonic* gages are supplied are Constantan (64-1), Nichrome V (64-2 and 64-7), and Alloy 1000 (64-6). If the maximum temperature is low enough, Constantan or Alloy 1000 gages are more desirable because of their much lower temperature coefficient of resistance and a coefficient of expansion ($dL/\text{temperature}$) close to that of steel. When the temperature exceeds 900° to 1000° F, the use of Nichrome V is required. Karma wire has also been used to measure both the static and dynamic strain in steel at high temperatures.

Strength of attachment between the resistance wire and the metal surface on which the resistor is mounted depends somewhat on the base metal. However, strains as high as 3500 micro-inches per inch are ordinarily satisfactory. The bond will be destroyed if a temperature is reached which is suffi-

ciently high to oxidize the base metal, the oxide being too weak to carry the necessary stress. At up to 3500 micro-inches per inch, quite satisfactory readings may be secured with standard strain gage technique and equipment.

With only one gage installed, absolute readings cannot be obtained. The relationship of the dL/L of the gage wire with temperature may or may not agree with the dL/L (or expansion) of the base metal with temperature change. This fact, plus the resistance coefficient of the gage and the possible presence of thermoelectric voltages, limits the single gage to dynamic indications unless the bridge can be balanced—with the base material heated to operating temperature—and the strain or load then applied. This is possible in limited cases, such as the testing of tensile strength specimens at elevated temperatures.

Circuit Configurations

Use of two gages in a half-bridge configuration permits the thermoelectric effect, coefficient of resistance, and dL/L effect to cancel out, allowing absolute readings. Of course, the installation will determine the accuracy of the end result. It is obvious that except in rare cases the use of a dummy plate for one gage will lead to excessive error due to deviation of temperature between

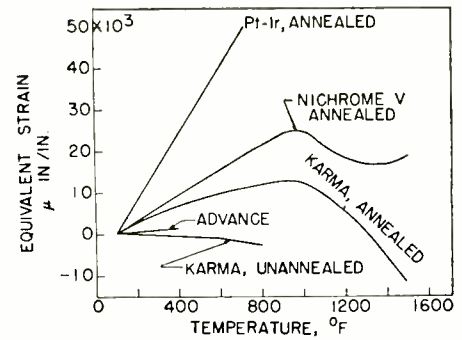

Fig. 3. Resistance change with temperature in strain gages mounted on steel.

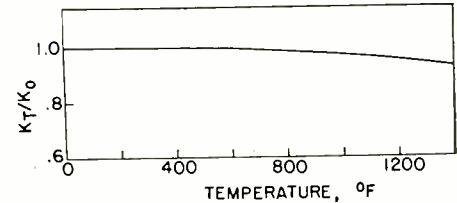
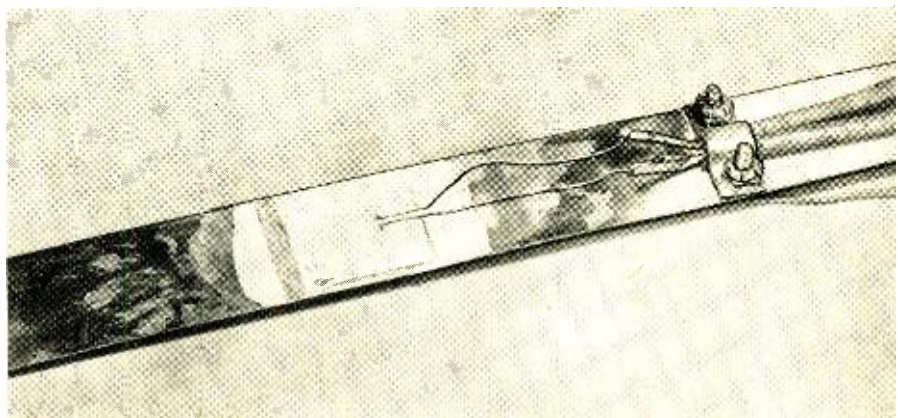

Fig. 4. Variation of the sensitivity factor with temperature for a strain gage made of Karma resistance wire.

the specimen and dummy plate. In some cases, the dummy gage may be mounted on the specimen at right angles to the stress line of a tensile or compressive load. When used with a bending beam, gages may be mounted on both sides of the specimen and wired per Fig. 2A, giving twice the sensitivity and an output which is independent of tensile loading. Different placement of the gages in the bridge circuit (Fig. 2B) makes the same beam independent of bending and only responsive to tensile or compressive loads. Unfortunately, it can be seen that any temperature-induced change of resistance in the gages would not cancel out with this last circuit configuration. Therefore, regardless of the method of installing the gages, this circuit is not adaptable. It can clearly be seen that the use of a dummy gage (or active gage) in the half-bridge circuit is difficult, and yet

(Continued on page -38-)

Fig. 5. Typical installation of a high temperature strain gage on a flat beam.



WATER LOADS

By

SAMUEL FREEDMAN

Sightmaster of California Company

powers of 500 watts and over, as compared to 1 to 10° F in practice for water loads using circulating systems. Finally, a point is reached where dry loads are unable to withstand the heating effect and disintegrate. At that point, there is no choice but to shift to water loads. The typical 10,000-watt u.h.f. television transmitter has more than five times the maximum power that the best dry load ever built can withstand.

Following the Korean outbreak, a development program was started to improve water loads. More than 100 glass and plastic designs were created and put under thousands of hours of live radar and VSWR impedance measuring tests to meet the requirements of microwave calorimetry and the need for improved dummy loads. Figure 1 shows a few of the loads developed under this program with the aid of a staff of expert German glass blowers brought to the United States by the *Kahl Scientific Instrument Corporation*.

The program, active since October, 1950, has been concerned with such details as:

1. Configuration of the water load tip
2. Configuration of the spiral section to permit use of adapters
3. Wall thickness and kinds of glass
4. Refractive index of water
5. Dielectric constant of water
6. Dielectric constant of the glass container
7. VSWR of a system due to the water loads
8. Water load placement in the r.f. field
9. Water load volume
10. Circulation of water through water loads
11. Viscosity of fluids under different temperatures
12. Hagen-Poiseule law of water volume vs. time vs. dimensions
13. Length and bore of capillary tubing
14. Effect of various flow rates and laminar effects

Figure 3 shows an efficient water load which will fit inside of an S-band 10-cm. (3000-mc.) wave guide, such as might

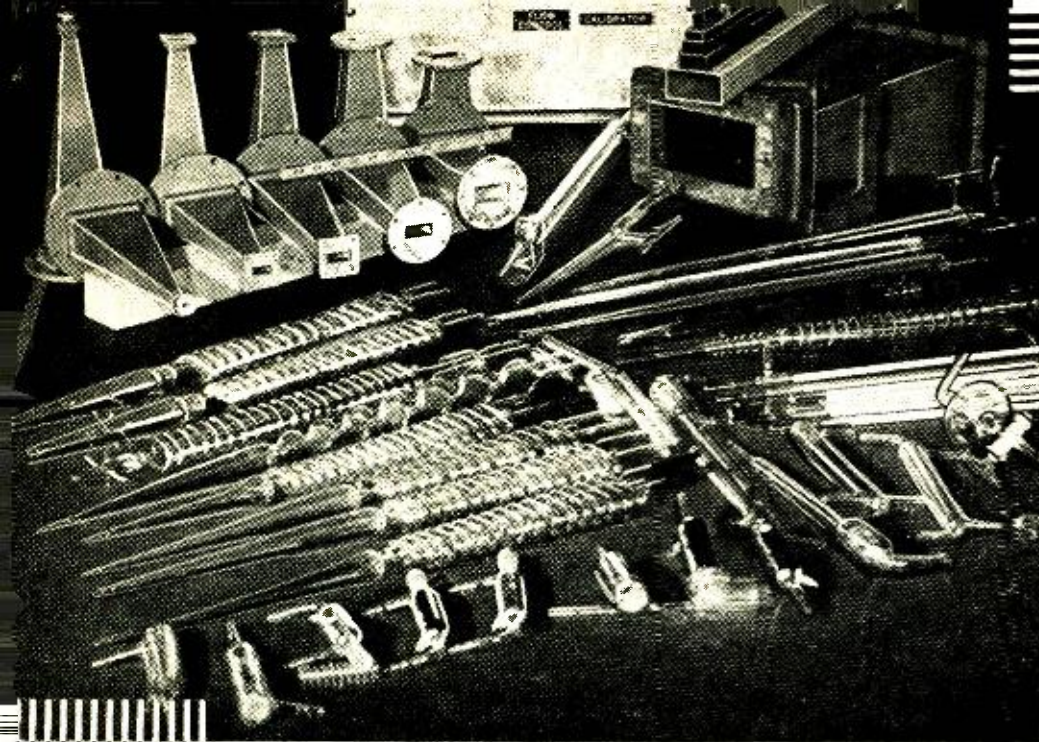

Fig. 1. Assortment of S-band glass water loads and other microwave equipment. The group of water loads on the left has decreasing VSWR from rear to front, varying from 1.18-1.22 down to 1.02-1.04.

Power absorption without radiation can be accomplished at very high outputs throughout the microwave region.

WHENEVER microwave energy is exposed to the pointed end of a tapered low-dielectric-constant container filled with a liquid, such energy is always absorbed and converted into a temperature rise of the liquid. This liquid is normally water and together with its container is known as a "water load"—the simplest and most effective means for attenuating or measuring high microwave energy sources such as the outputs of radar units, u.h.f. television transmitters, magnetrons or klystron tubes.

Where maximum powers are used, as in megawatt radar units and several thousand watt television transmitters, water loads are the only known and suitable types of dummy loads which permit tuning up of the apparatus with no radiation. As they are positive in operation, there is no danger of arcing in the transmitter, microwave tubes or transmission line wave guide systems under conditions of system malperformance. In military radar or comparable installations, they allow the apparatus to be tuned for peak performance without disclosing the presence of such stations in advance of combat utilization. In all cases, water loads may be used directly without the need for attenuators, directional couplers or relative power indicators. They are intended to be absolute devices working with the full-scale power involved, both average and peak, regardless of magnitude.

Prior to the development of satisfactory water loads, the common practice had been to use wave guide terminations filled with concrete-graphite or comparable mixtures surrounded by cooling fins. Such devices are subjected to cumulative heating effects and increased voltage standing wave ratios. Temperature rises up to several hundred degrees Fahrenheit may develop whenever these so-called "dry loads" are used for

Fig. 2. Cooling system for a very high power calorimeter water load.

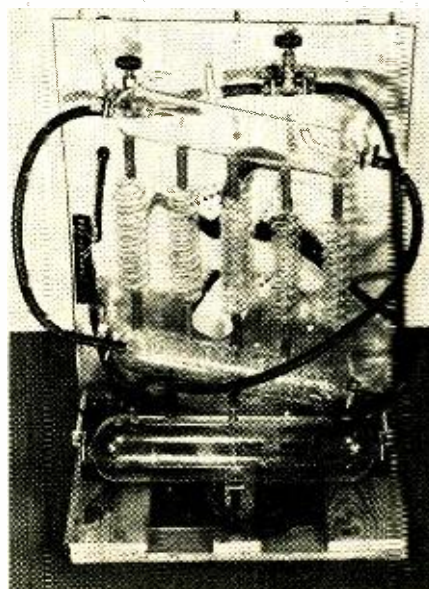

protrude from a microwave calorimeter connected to a radar. Similar construction is used for other bands. The sharper the tip and the longer the taper of the tip section, the lower will be the VSWR and the more efficiently the load will absorb energy in the dominant mode.

The back half of the configuration comprising the coiled section in Fig. 3 facilitates use of this water load when energy needs to be absorbed in other than the dominant mode, which might be the case if tapered adapters (shown in Fig. 1, background) are connected to permit it to operate with wave guides from systems on higher frequencies (smaller dimensions). The wafers visible within the glass tubulation tend to mix the circulating water and to intercept stray energy modes better. In some instances, the wafers also serve to break up the tendency of energy to use the glass surface as a wave guide and thus escape energy absorption. If very high flow rates are required, the water path terminates short of the sharp tip—where it has less constriction.

In the water load design of Fig. 3, water enters through the tubulation, proceeds to the tip through the outer tapered compartment, turns back through the inner tapered tube, and then passes through the wafers to the outlet. When the tip is left blunt, the VSWR may rise to as much as 1.2; but if it is brought to a sharp point, the VSWR will be 1.03 or less, provided that the tapered tip section exceeds three wavelengths.

Figure 4 shows three versions of a "zero flow rate" water load. There is no circulation of water in this type of load. As illustrated, the rear unit fits into a standard S-band (3000-mc., 3" x 1½") wave guide, the center load fits into a standard L-band (1000-mc., 6½" x 3¼") wave guide, and the front load fits into a standard X-band (9000-mc., 1" x ½") wave guide.

In the case of the large L-band version shown in Fig. 4, the internal water volume would be too great to measure medium or reduced power. This difficulty is resolved by using a hollow glass insert which will leave only a water film between the insert and the external surface of the glass. If the same number of wavelengths of absorption were provided with an L-band load as can be provided for higher frequency versions, the length of the load would be excessive and would subject the glass to undue stresses. One practice is

Fig. 3. Special load designed for minimum VSWR and water mixing.

Fig. 4. "Zero flow rate" extended-taper water loads for the S, L and X bands between 1000 and 10,000 mc.

to keep the length down to three or four wavelengths at the dominant mode and apply a correction factor (less than unity) to the final reading. An alternative is to have more than one such load in the system in tandem, so that each succeeding load absorbs three more wavelengths of energy distribution in the system.

Also, in the case of the L-band version or where insufficient wavelengths of absorption exist, provisions are made to interrupt the "wave guide" tendency of the glass in order to prevent the energy from traveling along the surface without being absorbed. This is accomplished by breaking up the energy path near the end and adding hollow inserts and water paths within the long ta-

pered tip section wherever necessary. Providing sufficient wavelengths of energy absorption and a very low VSWR on the X band is a simple matter because of the small wavelength dimension.

Although glass has been used for the containers in most of this development work, plastic containers are also suitable for water loads. Each material has its advantages and disadvantages.

When glass is used, desired shapes may be produced in small quantities, and repairs or modifications can be easily made by a competent glass blower. Glass is transparent, can withstand tremendous temperatures and pressures when they are gradually de-

(Continued on page -35-)

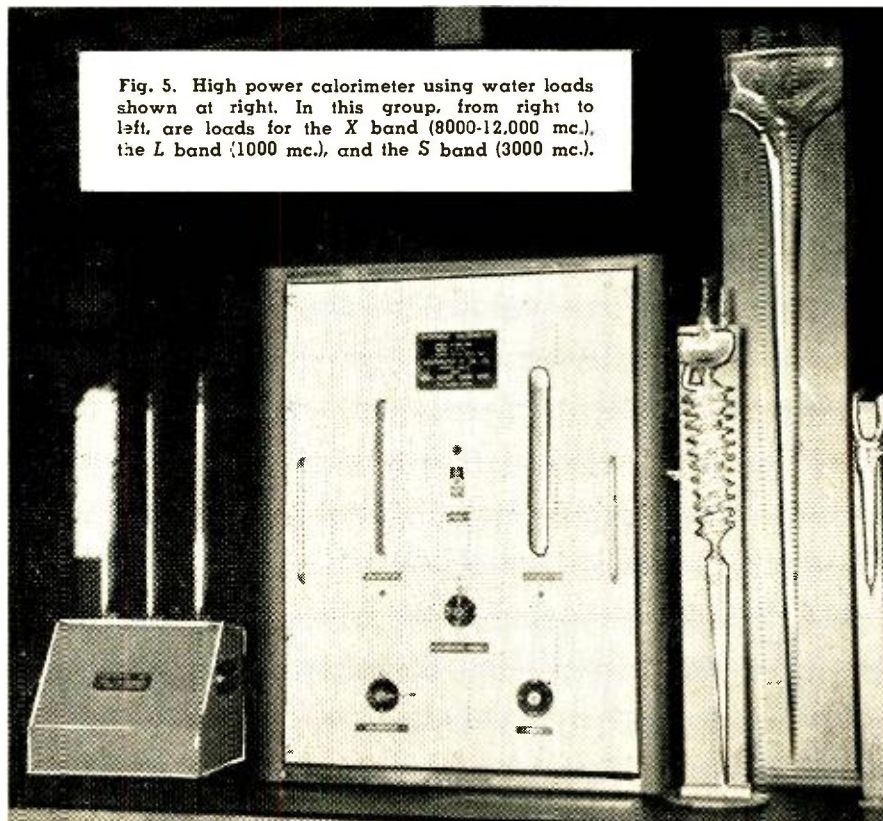

Fig. 5. High power calorimeter using water loads shown at right. In this group, from right to left, are loads for the X band (8000-12,000 mc.), the L band (1000 mc.), and the S band (3000 mc.).

ATTENUATING SPURIOUS FREQUENCIES

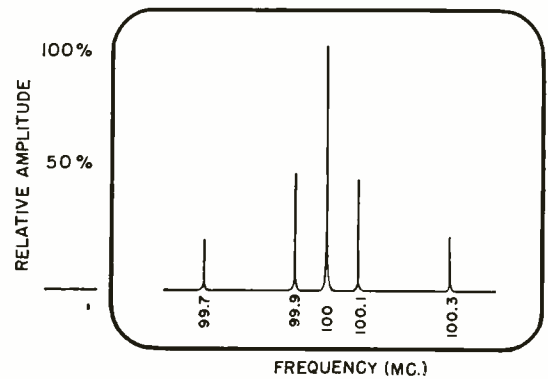

Fig. 1. Spurious sidebands of typical FM transmitter.

By B. E. PARKER

A suppression technique provides limiting or clipping and attenuates spurious frequencies by means of a series grid resistor in a frequency multiplier stage.

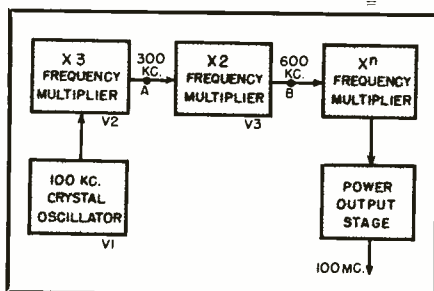

Fig. 2. Block diagram of FM or sound section of TV transmitter.

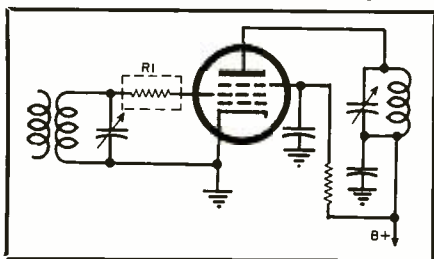
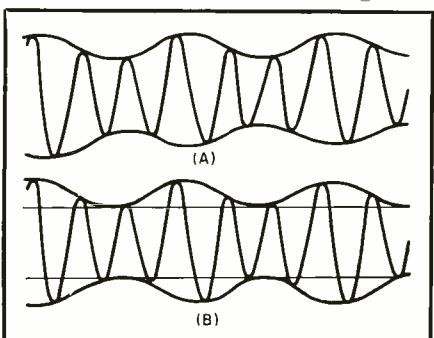

Fig. 3. Circuit addition for suppressing spurious sidebands.

Fig. 4. (A) Modulated 300-ke. waveform. (B) Effect of clipping.



ATENUATION or suppression of spurious frequencies or sidebands is normally accomplished by the use of tuned circuits, filters, or other frequency selective networks. The technique to be described here will not supplant these tried and proven methods but will more often be used to supplement such methods. Principal advantages of this type of suppression are:

1. Simplicity of circuitry
2. Low cost
3. No tuning or adjustment
4. Frequency insensitivity

The last advantage appears to be a direct contradiction of the purpose of the suppression. To see how this can be possible and to understand the basic principle of the technique, consider a typical FM broadcast transmitter as an example.

A frequency spectrum analyzer might display the spurious frequencies as illustrated in Fig. 1 with no modulation applied. Figure 2 is a block diagram of the pertinent parts of the transmitter. A casual analysis will quickly show that the 99.9-mc. and 100.1-mc. spurious frequencies are caused by the lack of attenuation of the 100-ke. (.1-mc.) crystal frequency "riding through" and amplitude-modulating the 100-mc. carrier, giving frequencies equivalent to the carrier plus and minus the 100-ke. (.1-mc.) crystal oscillator frequency.

Such spurious frequencies occur quite commonly in practice. An examination of the carriers of many of the FM, television and communication transmitters on the air today would show similar sidebands or spurious frequencies if viewed on a wide-band frequency spectrum analyzer. This is not necessarily a

reflection on the design of the equipment. Adjustment or "retuning" may just as often result in spurious frequencies.

It might be well to point out that these spurious frequencies should not be considered as parasitic frequencies caused by unwanted oscillations; rather, they are undesirable by-products caused by frequency multiplication. It is important that this distinction be borne in mind. The present discussion covers only instances in which frequency multiplication is employed.

To understand why the simple circuit illustrated in Fig. 3 is so effective and how it works, return to the signal at point A of Fig. 2. This signal is the output of the first tripler stage following the oscillator. The oscillator frequency of 100 kc. has been multiplied at point A to 300 kc. by V₂. If a wide-band oscilloscope capable of displaying the 300-ke. r.f. signal is connected to point A, a display something like Fig. 4A would be observed.

It is readily apparent that this display is very similar to that of the familiar amplitude modulation envelope of the conventional AM transmitter. In AM, the troughs and crests of Fig. 4A result in sidebands which appear above and below the carrier frequency. In this particular case, there is a 300-ke. carrier with 100-ke. sidebands. With subsequent frequency multiplication, the "modulation" shown in Fig. 4A will also be raised to the carrier output frequency. At the carrier output frequency of 100 mc., the sidebands will appear as in Fig. 1 unless previous stages and filters have sufficiently attenuated them.

(Continued on page -34-)

TRANSISTOR

NEGATIVE RESISTANCE CHARACTERISTICS

By

CHARLES A. KRAUSE

Project Engineer, Computer Research Corporation

By means of graphical analysis, the characteristics of point-contact transistors can be accurately predicted.

It has been shown that the negative-resistance characteristics of the point-contact transistor may be predicted with some accuracy by linear parameter approximation^{1, 2, 3}. The assumptions of linearity and of sharp transition between the current amplification and current saturation regions cause the predicted curves to have different points of inflection and a different shape than measured values. The chief value of the linear parameter approximation method would appear to be in the field of synthesis, i.e., the effect of transistor parameters and external resistors upon the negative-resistance characteristic is qualitatively indicated by the equations developed.

Methods of graphical analysis which have allowed the prediction of vacuum tube action may be advantageously applied here. The result will be a more realistic prediction which is completely accurate for the average unit. Time consumed by such an analysis is not overly great when a systematic procedure is developed, and a process of indirect synthesis may be developed from this procedure.

Another advantage of graphical analysis is that the voltages and currents of each transistor element become readily available. Thus, it is known immediately whether or not all voltages, currents, and dissipations are within rated values. The available a.c. output voltage becomes known in the calculation of the negative input resistance. There is also some academic value inherent in the graphical approach, in that the development of a negative-resistance characteristic from the manufacturer's data produces an understanding of the basic instability of a single point-contact unit.

There is no element of the transistor whose current is negligible, corresponding to the grid of a vacuum tube. Thus, it is always necessary to use two types of characteristic curves to perform a rigorous analysis. It will be shown, however, that use of only the collector (I_C) characteristic produces sufficient accuracy for many applications.

Each of the three basic transistor circuits (grounded-base, grounded-emitter, and grounded-collector) can exhibit regions of negative input-resistance if

the external parameters are properly chosen. The methods of analyzing the three connections graphically do not differ in principle, but the actual steps in a logical analysis are different enough to warrant individual attention.

In order to make a graphical analysis of an electrical circuit, the Kirchhoff voltage equations must be known. In the case of the usual vacuum-tube circuits, these equations are sufficiently simple so that the intervening step between the circuit diagram and the characteristic curves may be purely mental. For the transistor, however, not only are the equations slightly more complex, but also the familiarity derived from continual usage is not present.

Grounded-Base Connection

Inspection of the grounded-base circuit in Fig. 1A shows that:

$$V_E = V_{EB} + (I_E + I_C) R_B \quad (1)$$

$$E_{CC} - I_E R_B = V_{CB} + I_C (R_C + R_B) \quad (2)$$

In order to determine graphically the input resistance of this circuit, it is necessary to plot a curve of V_E vs. I_E . Inspection of Eqs. (1) and (2) shows that the following steps are necessary:

1. Value of emitter current I_E should be chosen.
2. A "load line" should be drawn on the collector characteristic with $(E_{CC} - I_E R_B)$ as the voltage intercept at $I_C = 0$ and with $(R_C + R_B)$ as the slope.
3. Intersection of the load line of step 2 with the emitter current curve chosen in step 1 yields the collector current I_C —solution of Eq. (2).
4. V_{EB} may now be read from the emitter characteristic, knowing I_C and I_E .
5. V_E is now known from Eq. (1).

It should be noted that for the $p-n-p$ transistor E_{CC} , V_{CB} and I_C will all be negative.

In illustrating these steps, the *Western Electric Type A-1768* point-contact transistor will be considered, with $R_B = R_C = 2000$ ohms, and $E_{CC} = -22.5$ volts. (One reason for choosing a *Western Electric* unit is that other companies have not made their emitter characteristic curves available.) The collector and emitter characteristics of the A-1768 unit are shown in Figs. 2 and 3. Following the five-step procedure outlined, Table 1 may then be prepared. The data of Table 1 are plotted in Fig. 4, together with the extreme values of the experimental re-

Fig. 1. (A) Typical grounded-base connection of a point-contact transistor; note that collector currents and voltages will be negative for a $p-n-p$ unit. (B) Grounded-emitter point-contact transistor circuit with external resistance in the emitter lead. (C) Typical grounded-collector transistor circuit.

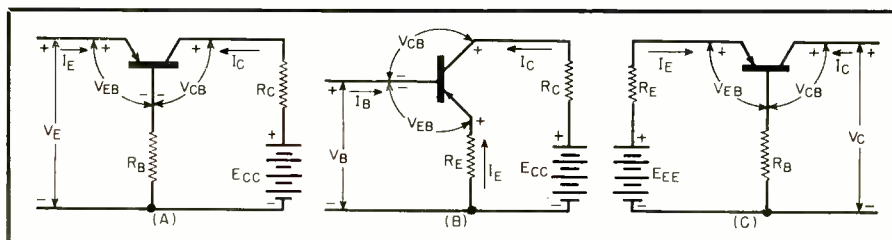

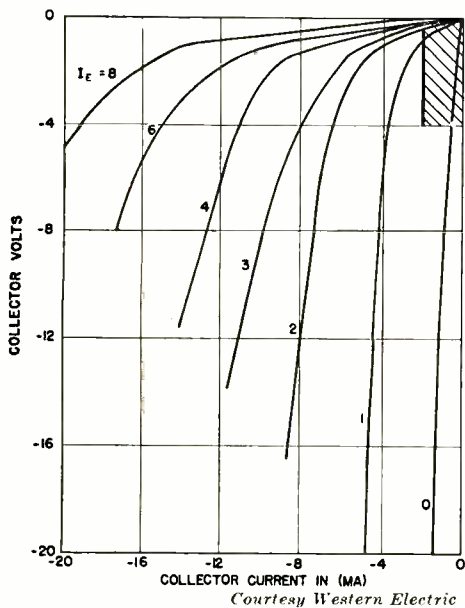

Fig. 2. Collector characteristic of the A-1768 point-contact transistor.

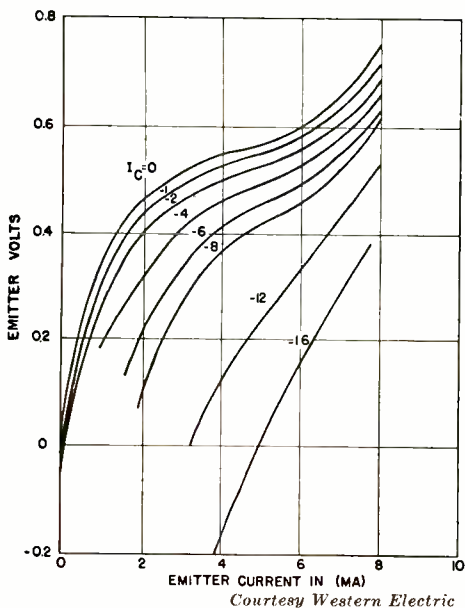
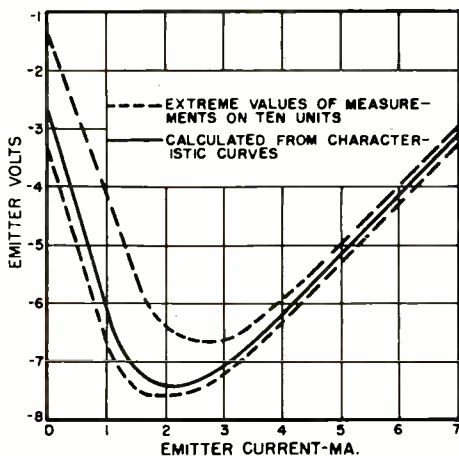

Fig. 3. Emitter characteristic of the A-1768 point-contact transistor.

Fig. 4. Grounded-base emitter characteristic of the A-1768 with $R_B = R_C = 2000$ ohms and $E_{CC} = -22.5$ volts.



sults obtained from ten different units.

The fact that the graphically determined curve lies everywhere within the measured extremes was not expected, due to the relatively small sample tested. Range of variation between the units seems small enough to compare favorably with the vacuum tube, another unexpected result. The correlation between theoretical and measured values attests to the fact that the given characteristics for this unit are very realistic. This is not always true of some transistors presently available (from other manufacturers).

It has been mentioned that the use of the collector characteristic is possible with some sacrifice of accuracy. Such use is accomplished by assuming that V_{EB} is very much smaller than $(I_E + I_C) R_B$. Inspection of Table 1 shows the magnitude of the errors involved. In Fig. 5, this version of the graphical method is compared with the completely rigorous method. Figure 5 also shows a characteristic obtained by the linear approximation method^{1,2,3}. For the linear approximation, it was assumed the $r_{11} = 150$ ohms, $r_{12} = 110$ ohms, $r_{22} = 6500$ ohms, $\alpha = 3.3$, and $I_{CC} = 0.4$ ma. It will be noted that different choices of the linear values will cause better correlation at a given point, but that these same values will increase discrepancies at other points. This merely emphasizes the fact that the device is not linear and may not be treated rigorously as such. The three curves of Fig. 5 illustrate the relative accuracies of the three methods. Proper compromise between time consumed and accuracy desired will dictate the choice of method.

The qualitative effects of each of the external parameters become apparent during the graphical analysis. For instance, if R_C becomes too large, the increased slope of the $(R_B + R_C)$ load

Fig. 5. Three methods of predicting grounded-base emitter characteristic. $R_B = R_C = 2000$ ohms, $E_{CC} = -22.5$ volts.

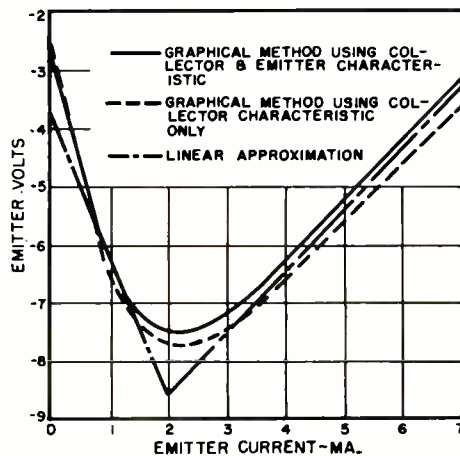

line causes ΔI_C to be less than ΔI_E . The negative resistance region then is eliminated. Experience in this type of analysis leads to intuitive methods of shaping the input-resistance curve. While these synthesis methods are not so straightforward as those derived from the linear approximation equations, they may lead to the desired result more quickly due to their increased accuracy.

It is always necessary to know that the rated dissipation of the transistor will not be exceeded if the input characteristic is to be put to use. The data of Table 1 are sufficient to calculate the collector dissipation P_C , defined as:

$$P_C = I_C V_{CB} = \{ (E_{CC} - I_E R_B) - (R_B + R_C) I_C \} I_C \quad (3)$$

For the parameters used in the example, the maximum value of P_C is about 35 mw., as compared to the rated maximum of 120 mw. This type of analysis has been helpful in determining the largest practical output power which may be obtained from a bistable device through increasing the internal dissipation up to its rated maximum. It should be noted that I_E must be limited in making such a calculation, or P_C will increase without bound.

Grounded-Emitter Connection

Equations for the grounded-emitter circuit shown in Fig. 1B are:

$$V_B = -V_{EB} - I_E R_E \quad (4)$$

$$E_{CC} - V_B = V_{CB} + I_C R_C \quad (5)$$

$$I_B = - (I_E + I_C) \quad (6)$$

The third equation (defining the base current I_B) is necessary, since the desired relationship is the V_B vs. I_B relationship. The following seven steps will yield this relationship:

1. Value of base-to-ground voltage V_B should be chosen.

(Continued on page -43-)

Fig. 6. Grounded-base emitter base characteristic of A-1768. $R_C = 4600$ ohms, $R_E = 1550$ ohms, and $E_{CC} = -22.5$ volts.

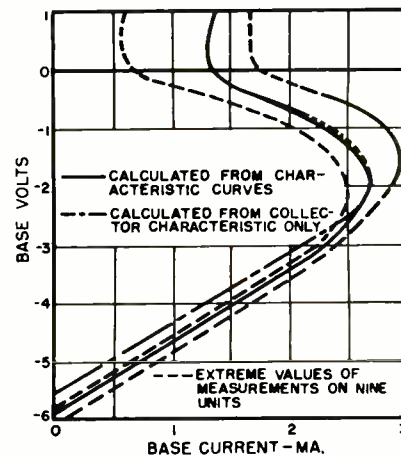

Eimac Klystron Report

X544

L BAND KLYSTRON

- 3 kw CW power output at 1400 mc
- Power gain of 1000 times

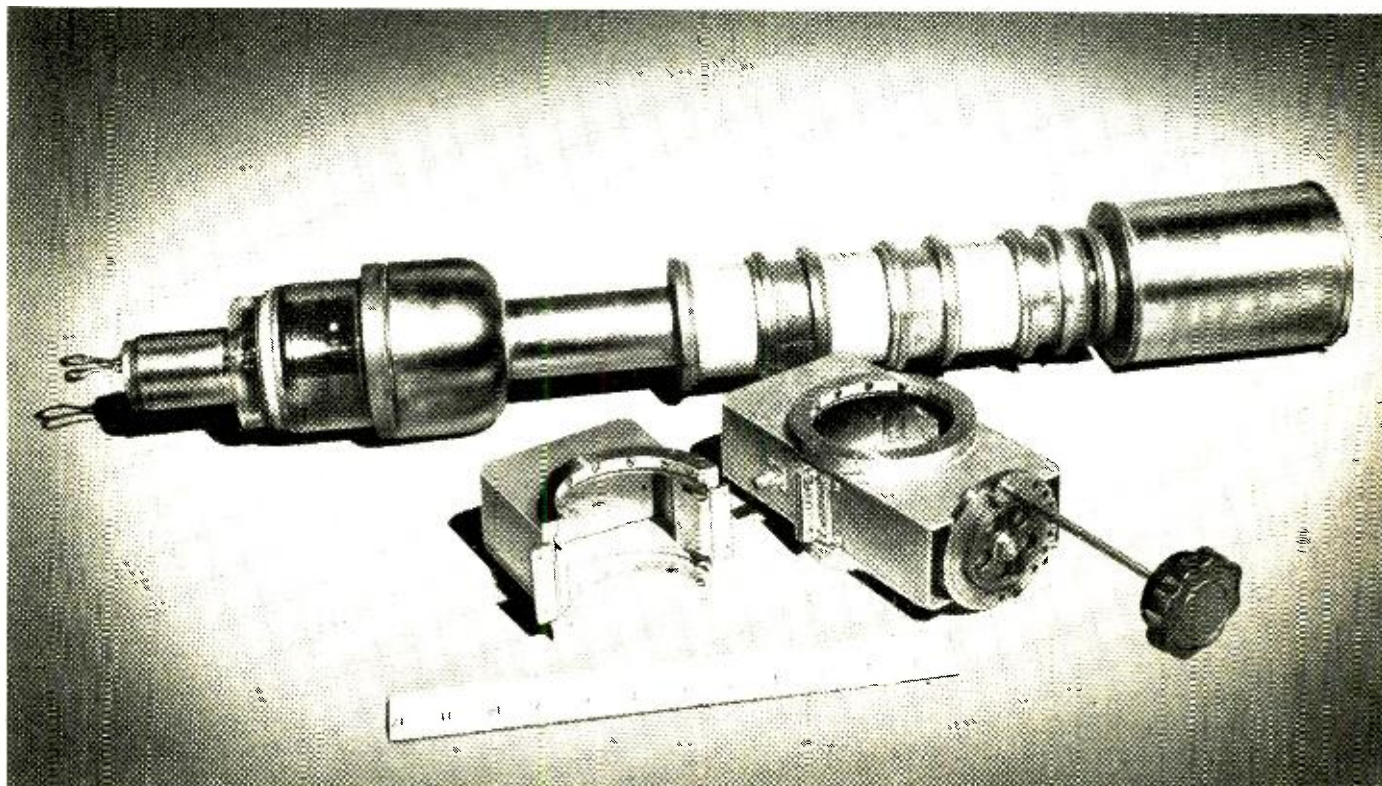

Eimac X544 and external tuning boxes.

A power gain of 1000 times at 1200-1400mc in CW operation has been registered by the new Eimac X544 three cavity, cascade type klystron. With only three watts driving power the X544 delivers 3kw power output. This high power and high power gain is possible over a 200mc range through the exclusive Eimac feature of completing tuning circuitry external to the vacuum system. Other features of the Eimac X544 are a long life cathode, ceramic tube cavities, practical design and light weight.

The X544 is another Eimac advancement in klystrons

for higher power at higher frequencies. Other Eimac klystrons include high power amplifiers for UHF-TV and sturdy reflex klystrons for use in conditions of severe shock, vibration and sustained acceleration at frequencies to 9600mc.

- *For further information contact our Application Engineering Department*

EITEL-McCULLOUGH, INC.
SAN BRUNO • CALIFORNIA

Eimac

MARK OF EXCELLENCE IN
ELECTRON-POWER TUBES

OPTICAL-SENSING DEVICE FOR COMPUTERS

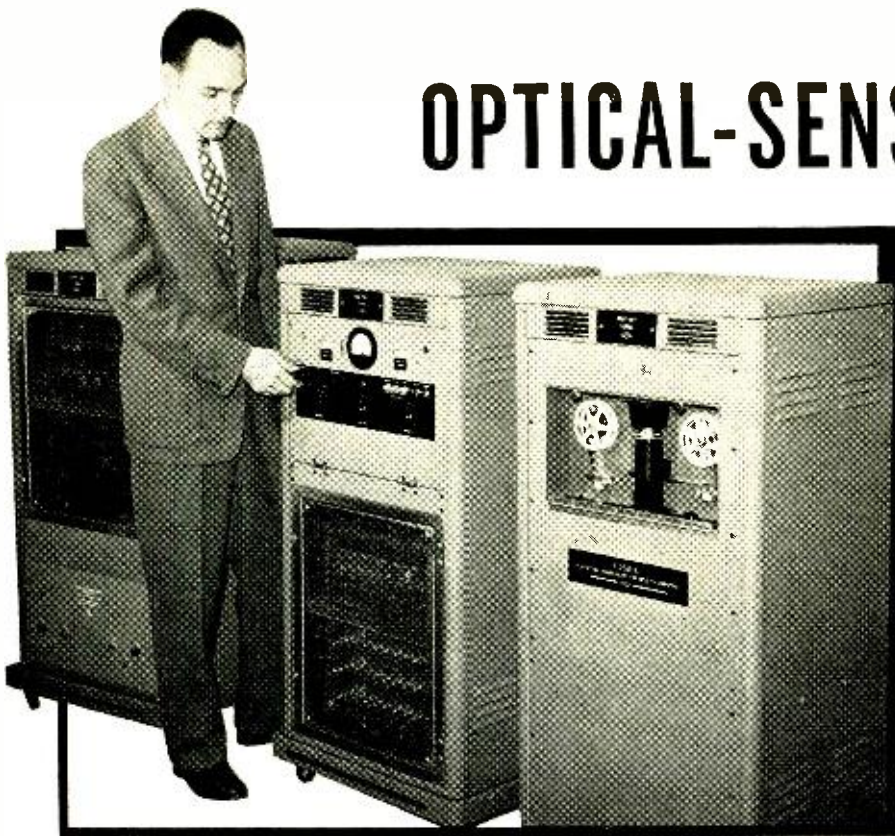

The three main cabinets which comprise this NBS instrument.

Information is processed by "FOSDIC" into a form which is suitable for direct input to large-scale computers.

WITH the development of many large-scale electronic computers in the past few years, there has been an increasing need for equipment to bridge the gap between the machines and their sources of information. This is especially true for computing systems which perform relatively little computation on a large mass of data obtained from many sources. Considerable attention has been given to computers and their input-output equipment, but relatively little has been given to "pre-input" apparatus or instrumentation which would permit a computer to have direct contact with sources of information. When human beings are considered as sources of information, only two even partially automatic means of communication are in general use. These are (1) typewriters of various forms and (2) special marking instruments such as punches or conductive pencils. An alternate method is through the manual preparation of punched cards. To these methods has now been added "FOSDIC," a completely automatic machine which processes marks made by an ordinary pencil or pen into a form directly usable by the computer. This device was developed by M. L. Greenough, H. D. Cook, M. Martens and associates of the National Bureau of Standards at the request of the Bureau of the Census.

The method of mark sensing used by FOSDIC (Film Optical Sensing Device for Input to Computers) is the detection of specific blacked-in areas or ovals in a large field of possible answers arranged on a sheet of paper. A "yes-no" answer is given two ovals, while a numerical answer is supplied with a vertical column of ten ovals for each decade. The desired information is indicated by the location of the marks. It then becomes the task of the sensing equipment to tell the computer precisely which ovals the enumerator has marked to signify his available information. Since FOSDIC senses the presence or absence of a mark by optical means, readings are not affected by the electrical conductivity of the mark or the

paper, or by any mechanical indentation of the paper due to lack of stiffness.

The scanning process is carried out on a frame-by-frame basis. Each frame is a microfilmed picture of one side of a sheet which may be as large as 14" x 16". The film is placed in an optical assembly between a cathode-ray tube with a moving spot that scans the image and a photocell that produces a varying electrical signal from the light beam that has passed through the film. Current maximum capacity is about 2800 marks per sheet—the present limit of adequate legibility of marks on the document. An individual film is scanned in 0.5 to 0.9 seconds. Allowing for film change and other functions, the total time per frame is about 1¼ seconds. The average information rate is approximately 2000 binary digits or 250 decimal digits per second.

In the design of mark-sensing equipment, the chief problem lies in developing a method to locate the individual ovals with the necessary degree of precision. The pickup heads in a mechanically registered system, such as that used for detecting conducting-pencil marks, are located at fixed distances from the edge of the document; assumptions are made that the edges are well-defined and that the paper stock has dimensional stability. In FOSDIC, however, the paper edge is replaced by a printed index mark below each column. When located by the scanning process, the index mark furnishes an exact guide to the column position. Column height, or distance from top to bottom oval, is not as critical as in a mechanical system since each answer is searched for over an area several times the size of the oval. Thus, with these degrees of freedom over ordinary scanning methods, the use of multiline documents on ordinary bond paper stock is feasible. Amount of information per document is considerably increased over punched cards.

The instrument is housed in four 42"-high cabinets. In addition, there is a unit containing magnetic tape-handling equipment and recording heads. The input cabinet contains the flying-spot scanning assembly. The main elec-

(Continued on page 43-)

Flow diagram of FOSDIC.

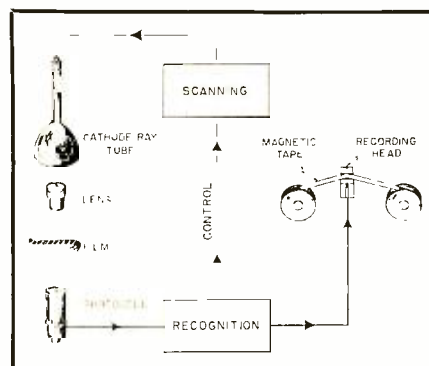

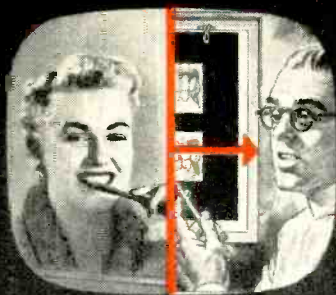

• Horizontal wipe



• Vertical split

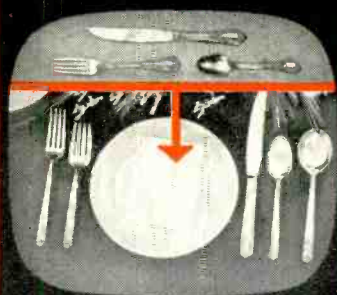

• Vertical wipe



• Vertical wedge wipe

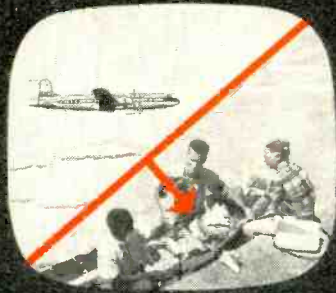

• Diagonal wipe



• Horizontal split



• Diamond inset and wipe



• Controllable corner insert

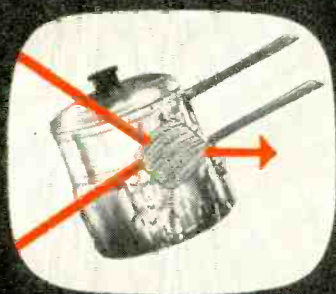

• Horizontal wedge wipe

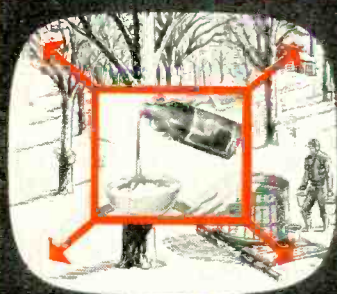

• Rectangular insert and wipe



• Controllable corner insert



• Optional special effect

12 ways to present your "commercial"

Now—with RCA's new Special Effects Equipment—you can have these 12 attention-getting effects right at your fingertips. You push the button for the effect you want. You swing the "control stick" (rotatable 360°) and put the selected effect in the picture wherever you want it. It's simple, inexpensive—requires no complicated equipment or extra cameras.

RCA's Special Effects Equipment consists of just two separate units; (1) a TG-15A control panel (shown below) and generator, (2) and a TA-15A amplifier. The Special Effects Panel can be inserted in any RCA Console housing. The other units can be mounted in your video racks. Installation couldn't be easier.

For quick delivery, order your RCA Special Effects Equipment direct from your RCA Broadcast Sales Representative.

← RCA Special Effects Control Panel—with 12 push-button selection and 360° rotatable stick control.



RADIO CORPORATION of AMERICA
ENGINEERING PRODUCTS DEPARTMENT
CAMDEN, N.J.

COMMUNICATION

REVIEW

TELEPHONE MICROWAVE SYSTEMS

Complete microwave radio relay systems especially designed for telephone circuits are being made available to independent telephone companies by the *Stromberg-Carlson Company*. Microwave radio relay portions of the systems will be manufactured for *Stromberg-Carlson* by the *Radio Corporation of America*, and will be similar to *RCA* microwave communications equipment already in use. The *SETCO* Division of *Stromberg-Carlson*, in Dallas, Texas, will manufacture the multiplexing and channeling equipment.

These systems will be of the single-sideband suppressed-carrier multiplex type, operating in the frequency range of 2450 to 2500 mc., and will provide duplex radio circuits capable of accommodating up to 30 voice channels. They can be easily coordinated with existing telephone equipment of either manual or dial types.

MOBILE RADIO EQUIPMENT

The first two-way mobile radio equipment to be designed and developed by *Allen B. Du Mont Laboratories, Inc.*,

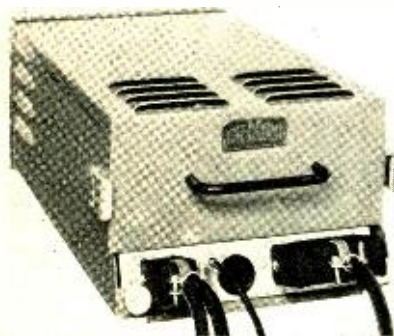

has been announced by its Mobile Communications Department. For operation in the 25-54 mc. band, the *Du Mont* MCA-101A mobile system is rated for 37-watts output at 25-45 mc. and 30-watts output at 45-54 mc.

Transmitter, receiver and power supply are all housed in a single metal cabinet readily installed in the trunk of a car or at any convenient location in a truck or service vehicle. Outstanding features are light weight and compactness: complete unit weighs only 35 lb. and measures 8 $\frac{1}{4}$ " \times 16 $\frac{1}{4}$ " \times 6". Complete information is available upon request from the Mobile Communications

Department, *Allen B. Du Mont Laboratories, Inc.*, Clifton, N. J.

AIRBORNE TWO-WAY RADIO

Motorola two-way v.h.f. radio has been installed on the *Goodyear* blimp "Ranger" by the City of Miami to en-

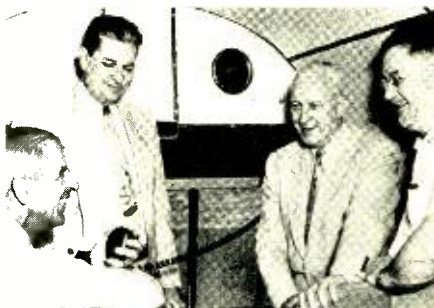

able its crew to communicate directly with ships at sea, all types of land vehicles, and even portable "handie-talkie" units. Two-frequency operation will put the "Ranger" in constant touch with all law enforcement agencies throughout six counties in southern Florida.

Shown discussing the new addition to Miami's public safety communications system are, left to right: Captain Verner L. Smith of the "Ranger"; Ben Demby, superintendent of communications for Miami; E. A. Evans, Miami city manager; and Col. Edward L. White, chief of the FCC's Safety and Special Radio Services Bureau.

MOBILE TRANSMITTER

Said to be the smallest, most compact unit per-watt-output available, the improved *Babcock* mobile D-X mitter six-band bandswitching radio transmitter incorporates many new, time-tested features. The *Babcock* Model MT-5A will be discontinued in favor of the new unit—Model MT-5B.

The MT-5B features a clear-vision meter with D'Arsonval movement which provides most complete metering of all circuits. It uses tubeless v.f.o., and the v.f.o. crystal switch and v.f.o. connector are now conveniently located on the front panel. Though designed primarily as an amateur transmitter, the MT-5B is finding wide application in commercial fields, with any desired tuning ranges being supplied on special order. Inquiries may be addressed to *Babcock*

Radio Engineering, Inc., 7942 Woodley Ave., Van Nuys, Calif.

"VARI-SPLITTER"

Exact realistic jam-free bandwidth is provided for all long-range reception of short-wave single-sideband transmissions by the Type MCL-500 Series "Vari-Splitter." Announced by *J. L. A. McLaughlin Corporation*, La Jolla, Calif., it has been designed to "patch" into the i.f. circuit of an installed high-quality single-sideband receiver. Its input/output frequency requirements match those of the receiver.

Models are available with provision to control the passband of one-, two-, three-, or four-channel single-sideband signals. Jamming attenuation is 60 db, 500 cps outside passband. This equipment is suitable for use with the latest multichannel single-sideband receivers employed in international radiotelephone service, or with FSK telegraph/teletype terminal equipment.

V.H.F. "MULTIPHONE"

A low-cost two-way v.h.f. portable communications unit—the *Skycrafters* "Multiphone"—is available for use on frequencies between 110 and 162 mc. This versatile unit can be used on dry batteries, 6-12 volts, d.c., or 115 volts, a.c., by inserting the corresponding power package in the lower half of the portable case.

While the "Multiphone" was developed primarily for use by the Civil Air Patrol on search and rescue missions, it also has wide application in industrial service. Additional information can be

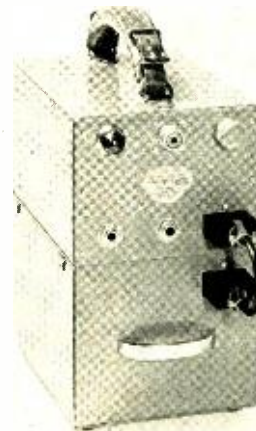

obtained upon request from *Skycrafters Aviation Radio*, 2453 E. Spring St., Long Beach, Calif.

RACING RADIO SYSTEM

Two-way radio supplied by the *General Electric Company* served as a communication link between "pit" truck and
(Continued on page -47-)

ENGINEERS

for **STABILITY** and **PROGRESS**

NOW IS THE TIME TO INVESTIGATE

Westinghouse

For industrial stability, progress and professional recognition, investigate Westinghouse! The Westinghouse Electronics Division . . . located in Baltimore, Maryland, is expanding its operations in the development of highly specialized commercial and military equipment. There are some excellent opportunities for engineers from the B.S. to the Ph.D. level. Investigate today!

- Job stability
- Extensive facilities
- Opportunities for advanced study
- Association with competent technical leaders

SYSTEMS ENGINEERS

Systems Planning
Systems Analysis
Systems Evaluation

in

- Fire Control Systems
- Missile Guidance
- Radar
- Indicators

ELECTRONIC CIRCUIT ENGINEERS

Applied Research
Development
Design

in

- Fire Control
- Communications
- Radar
- Missile Guidance

OR . . .

. . . if you have experience and education in communications, mobile radio, nuclear reactor instrumentation, technical writing, broadcast transmitters, high power audio amplifiers, high frequency heating application, servo mechanisms, magnetic amplifiers, etc., please apply.

If employed at your highest skill in a defense industry do not apply.

ANTENNA ENGINEERS

Applied Research
Development
Design

in

- Fire Control Antennas
- Radar Antennas
- Microwave Plumbing Techniques

COMPONENTS ENGINEERS

Evaluation
Standardization
Application

of

- Capacitors
- Resistors
- Switches
- Other Electronic Components

SEND TODAY

For your copy of "Gateway to an Engineering Future," including complete description of Electronics Division operations and the pleasant living conditions in Baltimore—home of the division.



Mr. R. M. Swisher, Jr.
Employment Supervisor, Dept. MA-1
Westinghouse Electric Corporation
109 West Lombard Street
Baltimore 1, Maryland

Please send me a copy of "Gateway to an Engineering Future."

Name _____

Address _____

City _____ State _____

Engineering Field _____

YOU CAN BE **SURE**...IF IT'S
Westinghouse

ELECTRONICS DIVISION
BALTIMORE, MARLAND

NEW PRODUCTS

BROADBAND PROBE

High sensitivity and convenient, broadband tuning are achieved in the FXR Type B200A broadband probe now available from *F-X-R Electronics*



& X-Ray Division, *F-R Machine Works, Inc.*, 44-14 Astoria Blvd., Long Island City 3, N. Y. It is tunable over the frequency range of 1.0 to 12.4 mc.

Optimum matching from the probe pickup to the easily replaceable crystal or bolometer detector is provided by the dual tuning control. There is an adapter for the Type 821 barretters, and a BNC output connector permits easy connection to a standing wave amplifier.

FREQUENCY METER

Designed for portability and low cost as well as accuracy, the Detectron DS-660 frequency meter will count and display an electrical or mechanical event which can be converted into a varying voltage of sufficient amplitude from 20 to 100,000 events per second. This unit derives its time base from the 60-cycle line, which in turn determines the accuracy—approximately .1%.

Among the many new features engineered into the DS-660 are: automatic and manual reset; self-checking;



display from 1 to 10 seconds; a basic unit which reads out to 10 kc. (four decades); and a new trouble-free dec-

ade plug-in unit. Further information on the DS-660 will be sent without obligation by *The Detectron Corporation*, 5420 Vineland Ave., N. Hollywood, Calif.

X-BAND MIXER

Premier Instrument Corp., 52 W. Houston St., New York 12, N. Y., has developed an extremely compact X-band mixer for radar or link applications, the maximum dimension of the mixer portion being $5\frac{1}{32}$ ". It can be furnished completely wired and tested in either brass, silver and rhodium plated, or aluminum.

In this compact arrangement are included: balanced search, balanced a.f.c.,

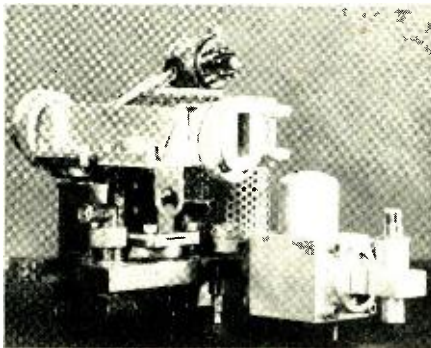

two local oscillator klystrons, provision for use of reference cavities where desired, wide range of crystal current adjustment, and built-in crystal protection. The design facilitates use of plug-in pre-i.f. and a.f.c. circuitry.

INDICATOR-CONTROLLER

Maintaining a vacuum system in any preset range between 1 and 1000 microns of mercury, the *Hastings* vacuum indicator-controller provides upper and lower limit control and automatic reset. After the user has set the contacts for the limits required, the indicator-controller affords a stable, fully automatic means of controlling the vacuum at the desired level. The logarithmic scale provides easy readability and control of accuracy in the lower ranges. Dimensions are 14"x8"x8".

Developed by *Hastings Instrument Company, Inc.*, Hampton 11, Va., this instrument utilizes gage tubes with noble metal thermocouples and nickel-plated housing, assuring freedom from

outgassing and system contamination. A typical application is the controlling of a vacuum pump to maintain the vacuum within given limits; it may



also be used to operate an alarm when the vacuum moves to either upper or lower limit.

BOLOMETER

A new bolometer of the hot wire type is now available for the detection of microwave and u.h.f. frequencies from *NARDA—Nassau Research & Development Associates, Inc.*, 66 Main St., Mineola, N. Y. It is manufactured by a new process that permits the use of a continuous plastic sleeve enclosing the hot wire, which results in a higher tensile strength than previously available.

The *NARDA* N-821B requires a bias current of 8.75 ma. to obtain the operating resistance of 200 ohms. Detection is square law for power levels within any 40-db interval. Burn-out power is over 15 mw., and the sensitivity is 4.5 ohms/mw.

K-BAND TEST HORNS

For use in radar microwave testing procedures, the new series of precision-cast K-band test horns developed by *Airtron, Inc.*, covers the frequency range from 12,400 to 40,000 mc. Em-



ployed as test receiving antennas, these horns serve such purposes as location of r.f. leakage and approximate gain checks on microwave antennas. As transmitting horns, they can be applied in antenna pattern measurements, illumination of parabolic reflectors or lens arrays, and for termination of high power systems into space.

Airtron K-band test horns are available in three models: Type No. 68053, covering a range from 12.4 to 18.0 mc.; Type No. 68052, for 18.0 to 26.5

(Continued on page -40-)

QUALITY

PERFORMANCE

LINK

NEW!

LINK 6000 SERIES

AVAILABLE IN THE 25-50 MC BAND & 152-174 MC BAND

- Designed around stringent specifications.
- Wired for 6 or 12 volt operation.
- For single or dual channel operation, for adjacent or split-channel operation.
- Available with vibrator or dynamotor power supply.
- 3½ watts of audio output.
- Plug-in metering position.
- All components accessible for service.
- Power supply and control circuits completely plug-in.
- Simple installation, low maintenance costs.

THERE IS NO BETTER EQUIPMENT AT ANY PRICE!



DESIGN

PRODUCTION ROLLING ALONG TO MEET ALL DELIVERIES

ONCE AGAIN INTRODUCING THE RUGGED, CAPABLE

LINK 2365

Link Radio continues to produce all its established, recognized mobile equipment of the past years without deviation from accepted design.

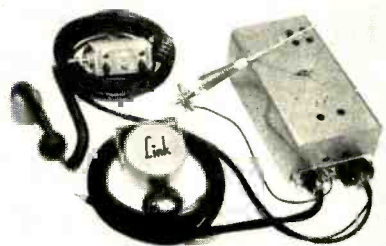

SERVICE

NEW

LINK 5000 SERIES

FOR AC/DC OPERATION IN THE 152-174 MC BAND & 30-50 MC BAND

A base station for operation in emergency services on 117 volts AC and 6 or 12 volts DC to guarantee uninterrupted operation in event of regular power failures.

DESIGNED ESPECIALLY FOR CIVILIAN DEFENSE USE!



MURRAY PLATT, president



WRITE TODAY FOR LITERATURE

LINK RADIO CORPORATION

125 WEST 17th STREET • NEW YORK 11, NEW YORK

NEW TUBES

COLOR TV RECEIVER TUBES

Four of the latest tubes to be announced by the Tube Department of *Radio Corporation of America*, Harrison, N. J.,—all for use in color television receivers—include: a tricolor kinescope; a half-wave vacuum rectifier for rectifying high-voltage pulses in scanning systems; a medium- μ triode—sharp-cutoff pentode for diversified applications; and a sharp-cutoff beam triode for regulation of high voltage power supplies.

Tricolor Kinescope

A directly viewed picture tube of the glass-envelope type, the RCA-15GP22 is capable of producing either a full-color or a black-and-white picture 11½"×8½" with rounded sides. It utilizes three electrostatic-focus guns spaced 120° apart with axes parallel to the tube axis, together with an assembly consisting of a shadow mask and a plane, tricolor, Filterglass phosphor-dot (screen) plate located between the shadow mask and a clear-glass faceplate.

Pulsed Rectifier

Of the glass-octal type, the RCA-3A3 is a half-wave vacuum rectifier rated to withstand a maximum peak inverse plate voltage of 30,000 volts. This tube (shown at left) can supply a maximum peak plate current of 80 ma. and a maximum average plate current of 1.5 ma.

Triode-Pentode

Containing a medium- μ triode and a sharp-cutoff pentode in one envelope,



the RCA-6AN8 is a general-purpose, multiunit tube of the 9-pin miniature type. The triode unit with its relatively high zero-bias plate current is useful

in low-frequency oscillator, sync-separator, sync-clipper, and phase-splitter circuits; the pentode unit with its high transconductance may be used as an i.f. amplifier, video amplifier, a.g.c. amplifier and reactance tube.

Beam Triode

The RCA-6BD4 (right) is a low-current beam triode designed specifically for the voltage regulation of high-voltage, low-current d.c. power supplies. It has the following maximum ratings: d.c. plate voltage—20,000 volts; d.c. plate current—1.5 ma.; and plate dissipation—20 watts.

EXPERIMENTAL TRANSISTOR

Sizable quantities of an experimental high-power transistor may be obtained from *Transistor Products, Inc.* Designated as the experimental Type X78.

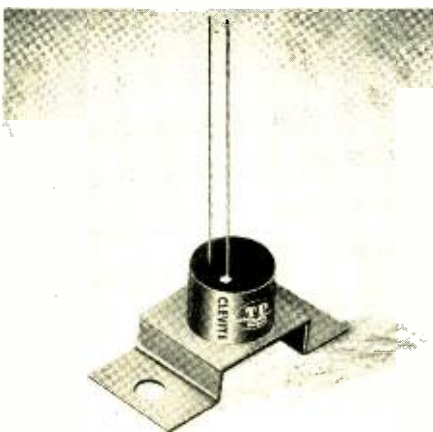

this unit is a *p-n-p* diffused junction transistor useful principally when employed in matched pairs in class B audio amplifier applications. Subminiature matching transformers have been made available for use in such a circuit.

Although the unit is derated if operated at temperatures above 80° F, and the manufacturer does not represent it to be of high alpha, a minimum power gain of 10 db at room temperature is guaranteed when the Type X78 is used in the recommended circuit. For further information, write to *Transistor Products, Inc.*, Snow & Union Sts., Boston 35, Mass.

C. W. MAGNETRON

A miniature c.w. magnetron has been announced by *Microwave Associates, Inc.*, for use in the 9800-10,000 mc.

range. Physically resembling a standard receiving tube, the 6444 operates from a plate supply of 450-500 volts and a heater supply of 6 volts. It is fixed-tuned, incorporates the new long-life Philips dispenser-type cathode, and delivers 1 watt of c.w. energy into a standard klystron-type output.

Originally developed by the Signal Corps Engineering Laboratories as the



ESM-48, the 6444 is extremely rugged, nonmicrophonic, and is suited for Doppler-type radar and other field and laboratory use. For further information, contact the Sales Department, *Microwave Associates, Inc.*, 22 Cummington St., Boston 15, Mass.

JUNCTION TRANSISTOR

Now in production at *Philco Corporation* is a transistor that will operate with the same high degree of excellence in mass-produced units as in laboratory models—eliminating the need for individual selection of transistors or associated components to meet equipment specifications. This new diffused alloy junction transistor is one of the smallest ever produced.

Leads are fused in glass, and the entire transistor is enclosed in a metal envelope. An instantaneous resistance weld hermetically seals the complete unit. Descriptive literature and specifications are available from the Government & Industrial Division, *Philco Corporation*, Philadelphia 44, Pa.

TV PICTURE TUBES

Westinghouse Electric Corporation has announced a line of 21" Reliatron (trade name) television picture tubes which are three inches shorter than previous 21" models, yet have a 5% increase in viewing area. Four new tube types are available in this line, all directly viewed picture tubes of rectangular glass construction with a nominal screen diagonal of 21" and external conductive coating.

The 21ALP4 and 21ALP4A (alumi-
(Continued on page 46-)

RCA MICROWAVE
radio-relay communication
and remote control



Unattended "booster" stations—interspaced with regular pumping stations—
increase pipe line capacity 25%

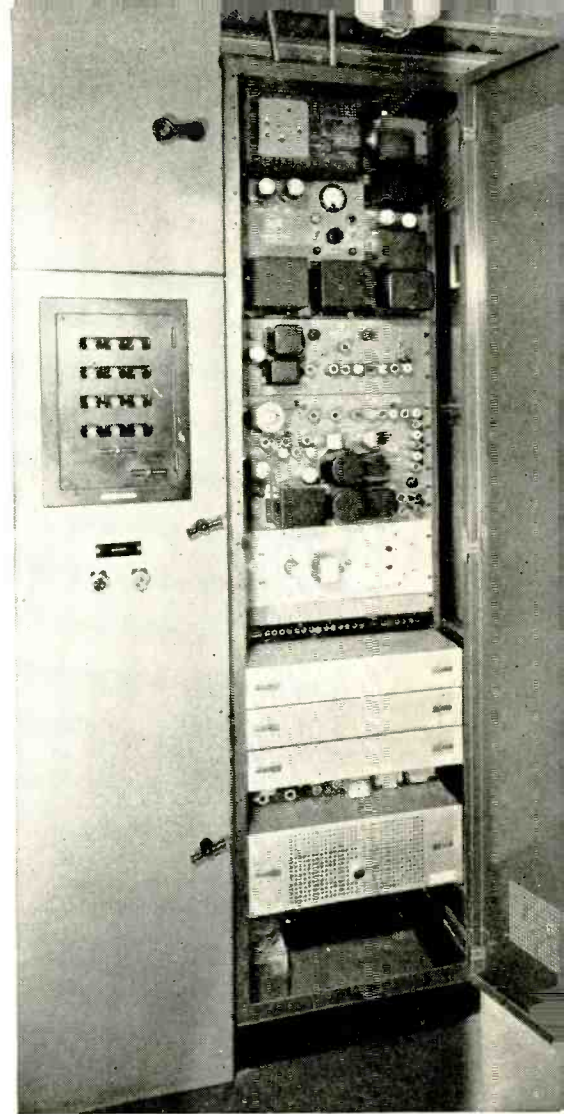

Close-up of equipment at unattended "booster" station. Cabinet open at right displays 960-mc RCA Microwave transmitter-receiver

How remote supervisory control (via Microwave) helps SUNRAY reduce pipe-line operation costs

TWO YEARS of successful operation have proved that Sunray Oil Corporation's microwave system is a cost-cutting investment. Two operating positions now fully control five pumping stations. At the same time, 25% greater volume can be run through the pipe lines.

A 97-mile pipe line is used to interchange products between the company's refineries at Sunray Village (Duncan) and Allen, Oklahoma. An attendant at the main pumping station controls and monitors two unattended booster pump stations. On another pipe line 85 miles long, the operator at the main station controls a "booster" 31 miles away. On both pipe lines, RCA 960-mc Microwave systems link the control points and remote-operated "boosters."

HANDLES MANY CHANNELS

Sunray engineers selected RCA Microwave on the basis of cost, reliability, and capacity. Because of its capacity, microwave is the least expensive form of communication per channel mile.

Maintenance-wise, too, microwave cuts costs. Unattended relay stations, spaced miles apart, cost less to maintain than direct wire. RCA Microwave is virtually weather-proof . . . outage time is next to zero.

HAS HISTORY OF RELIABILITY

Since 1946, RCA has installed many fully reliable microwave systems, some over a thousand miles long. All have proved themselves in performance—for utilities, government agencies, telegraph companies, turnpikes, as well as pipe lines.

In addition to remote control and supervisory functions, RCA Microwave provides as many voice and teletype channels as needed—and does it with a minimum of frequency space. It employs readily avail-

able tubes and familiar circuits which are easy to service. It can be interconnected with telephone lines, switchboards and mobile communication systems.

COMPLETE SERVICE AVAILABLE

If desired, RCA supervises survey, construction and installation—provides a complete single-source, single-responsibility service. For complete information, mail the coupon below. And remember, the RCA Service Company provides nation-wide installation and service facilities.



RADIO CORPORATION of AMERICA
COMMUNICATIONS EQUIPMENT
CAMDEN, N. J.

Dept. E157, Building 15-1

Without obligation on my part, please send me your free booklets on:

- Pipeline Microwave Systems Radio-controlled Booster Increases Production

Name _____ Title _____

Company _____ Address _____

City _____ Zone _____ State _____

- Have an RCA representative get in touch with me.



Speeding Electronic Progress through

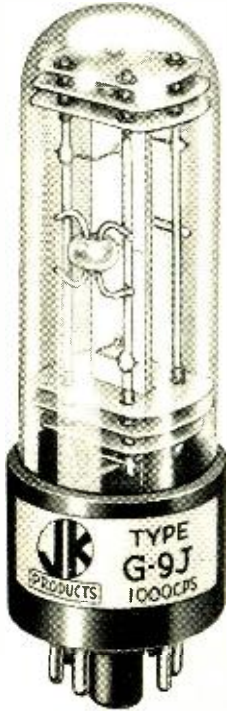

CRYSTAL RESEARCH



Now, the range of the JK G-9J has been extended to cover 1000 cycles to 10 kc. This provides a convenient source of stable time base for a wide variety of measurement problems, with a minimum of circuitry. Ideal for applications such as compact digital counters in the audio range. Balanced nodal-point mounting minimizes microphonics found in other resonators in this frequency range. Write for application and engineering information.

JK Stabilized G-9J Crystal
in the 1000 CPS to 10 kc range

Designing a New Product?

We can serve you best when you consult us at the beginning of your frequency control problems. An early consultation lets you integrate the newest JK developments and findings with your own product design research. Our extensive research facilities are here to serve you.

THE JAMES KNIGHTS COMPANY

Sandwich, Illinois



CRYSTAL HANDBOOK
A handbook of crystal theory and practice compiled by our research division as an industry service. Copies available at \$1 each.

TECHNICAL BOOKS

"THERMIONIC VALVES—Their Theory and Design" by A. H. W. Beck, B. Sc. (Eng.), A.M.I.E.E. Published by *Cambridge University Press*, American Branch, 32 East 57th St., New York 22, N. Y. 570 pages. \$12.00.

A theoretical account of the behavior of thermionic high vacuum devices, this book should primarily be of use to graduates with a first degree in physics or electrical engineering and those who are starting independent work in this field. It should also prove useful to practicing engineers and others engaged in the industry.

Material is divided into three parts, the first dealing with the fundamental physics of thermionic emission, etc. The second part considers the general theory of the fields set up by charged conductors and the electron motions resulting therefrom, while the last and longest section applies all of this material to the study of various classes of tubes.

This book is strongly biased towards microwave tubes as the author feels that existing textbooks deal adequately with ordinary gridded tubes and that a wide variety of interesting and useful phenomena is encountered in the microwave field.

"MICROWAVE SPECTROSCOPY" by M. W. P. Strandberg, Associate Professor of Physics, Massachusetts Institute of Technology. Published by *John Wiley & Sons, Inc.*, 440 Fourth Ave., New York 16, N. Y. 140 pages. \$2.50.

Relevant information used to obtain and interpret microwave spectroscopic data is made conveniently available in this Methuen Monograph on Physical Subjects, a compact, unified treatment of the field. The treatment presupposes some familiarity with modern quantum mechanics and matrix methods, background for which is readily accessible in the bibliography.

The text begins with a calculation of the quantum energy levels of a rotating molecule, and considers the various perturbations which must be recognized to interpret precise experimental data. Final sections deal with the instrumentation necessary to measure the frequencies in the microwave region which are characteristic of differences between the energy levels. The study of these rotational levels and their measurement includes the bulk of present microwave spectroscopic material.



*Emblem . . . of Engineering Opportunity . . .
and Professional Progress*

DEVELOPMENT • DESIGN • SYSTEMS ENGINEERING

*Consider RCA's engineering opportunities listed below!
For professional association in the field of your choice, write:*



John R. Weld, Employment Manager
Dept. 304E Radio Corporation of America
30 Rockefeller Plaza, New York 20, N. Y.

Air Conditioners • Allimeters • Ampule Inspection • Analog Computers • Antenaplex • Antenna Systems • Aviation Radio • Beverage Inspection • Broadcast (AM and FM) • Calibration Equipment • Camera Tubes • Cathode Ray Tubes • Color and Monochrome TV Cameras, Receivers, Studio Equipment, Transmitters • Communications Equipment • Counter Measures • Custom Recordings • Digital Computers • Direction Finders • Early Warning • Electron Microscopes • Electronic Components • Engineering Services • Facsimile Apparatus • Field Services • Gas Tubes • High Fidelity • Industrial Products • Information Displays • Inter-Comm Equipment • Kinescope Tubes • Loran • Microphones • Microwave • Microwave Tubes • Missile Guidance • Mobile Communications • Oscillograph Tubes • Phonograph Records • Photo Tubes • Power Tubes • Public Address Systems • Radar • Radio Receivers • Receiving Tubes • Rectifier Tubes • Semi-Conductors • Servo-Mechanisms • Shoran • Sonar • Sound Film Projectors • Sound Powered Phones • Special Apparatus • Storage Tubes • Tape Recorders • Teletypewriter • Test Equipment • Theater Equipment • Theater Television • Transistors • Tube Parts • "Victrola" Phonographs

Tmks®



"PRE-HEATER" FOR RADIO TUBES

Radio tube production will be increased as the result of a "pre-heater" for tempering glass that has been developed at the Radio Tube Division of *Sylvania Electric Products Inc.*, Emporium, Pa. Known as a "broken-back" pre-heater, in contrast to an older-styled but slower circular pre-heater, it consists of an automatic conveyer



belt which feeds radio tube mounts to the sealing machine operator (left) and the heater unit itself.

The operator (right) places the tube mounts into the bulbs and then loads them into the conveyer belt. Each tube is transported through the pre-heater to the sealing machine operator, who has only to raise his hand about four inches in order to take the mount from the conveyer and insert it into his bulb-sealing machine.

COMPUTER COMPANIES

Librascope, Incorporated, of Glendale Calif., a subsidiary of *General Precision Equipment Corporation*, has announced the acquisition of the *Minnesota Electronics Corporation*, of St. Paul, Minn., manufacturer of digital computers and components. Use of the subminiature magnetic decision elements recently developed by the *Minnesota Electronics Corporation* in combination with *Librascope's* advanced computer techniques is expected to result in much improved and highly reliable digital computers for both industry and military applications.

MEASURING INSTRUMENT

Bridge-type measurements can be made up to 100 times faster and more consistently accurate than with conventional galvanometers by means of

a new electronic measuring instrument developed by *Minneapolis-Honeywell Regulator Company*. Housed in a portable, compact case, this instrument—called an "ElectroniK" null indicator—speeds up resistance and potential measurement by utilizing a precision potentiometer and bridge.

To operate the null indicator, it is only necessary to close a switch and balance the bridge; the balance point is indicated by the return of the indicator pointer to zero. In addition, this instrument is not affected by vibration or overloads of several hundred per cent. Data Sheet 10.0-12, giving complete information, is available from the Industrial Division of *Minneapolis-Honeywell Regulator Company*, Wayne & Roberts Aves., Philadelphia 44, Pa.

AIRBORNE SEARCH RADAR

The most powerful airborne search radar yet developed is being produced at the *General Electric Company* plant at Utica, N. Y., under contract with the U. S. Navy's Bureau of Aeronautics. It will be installed in a number of Navy and Air Force aircraft, including the flying radar stations being built by *Lockheed Aircraft Corporation*. These giant planes will fly off the Atlantic and Pacific coasts, and supplement the "radar fence" now guarding the U. S. and Canada against enemy air attack.

Special provisions in the *G-E* indicator system will permit the use of this



radar for antisubmarine, aerological weather reconnaissance and navigational purposes in addition to aircraft detection. The indicators are assembled

as shown in the photograph. Radar information is displayed on a cathode-ray tube screen.

ULTRASONIC POWER

Cleaning or degreasing of small parts and metal objects can be greatly accelerated with the "Sonogen" Model 500 ultrasonic-power generator. It functions by activation of the cleaning solvent in which a low-voltage focused ceramic transducer is immersed. In-

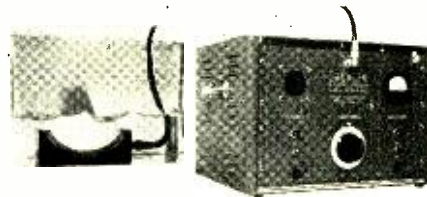

stallation in conventional vapor-degreasing systems is facilitated by long cables between the power unit and the transducer.

In addition to cleaning, the "Sonogen" is an economical source of ultrasonic power for many other laboratory and production uses involving liquids—such as emulsification, dispersion, and the acceleration of chemical reactions. For further details, write to *Branson Instruments, Inc.*, 430 Fairfield Ave., Stamford, Conn.

SPURIOUS RADIATION COMMITTEE

A special committee on spurious radiation has been appointed by the RETMA, with Dr. W. R. G. Baker, director of the RETMA Engineering Department, acting as chairman. The committee is authorized to develop an industry program for the voluntary suppression of spurious radiation by TV receivers. After the program is developed, it will be presented to the FCC for approval before becoming operative.

MONITORING ELECTRON TUBES

Performance and improvement of the millions of tubes used in complex military electronic equipment can be traced in large part to a group of scientists at New York University. The work of these scientists, who provide the nerve center for monitoring research and development of every electron tube used in the U. S. Armed Services, is described in the January, 1954, issue of "Engineering Research Review," available on request from the Office of Information Services, New York University, New York 53, N. Y.

SILICON TRANSISTORS

Because of the characteristics of the germanium used in transistors to date,

certain applications involving high wattage and the resultant high temperatures, as well as applications with high ambient temperatures, have not been practical. Experimental transistors made of silicon have now been developed for the Department of Defense by the *Raytheon Manufacturing Company*, Waltham, Mass., which are expected to overcome this difficulty.

Raytheon's silicon transistors have been tested at temperatures ranging from 77° F to 350° F and higher, and on a laboratory basis, the new devices have been proved capable of meeting the stringent requirements of military use. However, due to production problems, it is not expected that these silicon transistors will be made available in quantity for some time to come.

PRINTED CIRCUIT PRODUCTION

Complete service in producing printed circuits is rendered by *Insulated Circuits, Inc.*, 115 Roosevelt Ave., Belleville, N. J., including development, design and research activities for all possible applications. Capable of dealing with large or small runs, the company will also handle complete subassemblies in its own plant. Shown in the photo-

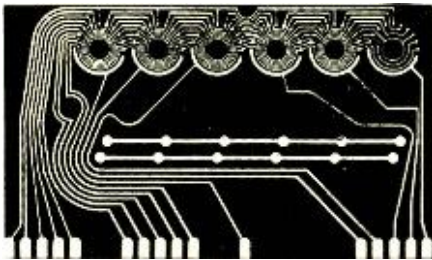

graph is a flush switch plate which is indicative of current production. 150 holes .020" in diameter can be plated through 1 sq. ft. of printed circuit board .125" thick by this concern.

RADIO DISTURBANCE WARNINGS

Short-term radio propagation forecasts for the North Pacific area are being broadcast by the National Bureau of Standards from its standard frequency broadcasting station WWVH—the Hawaiian counterpart of the Bureau's Washington station, WWV. The disturbance notices tell users of radio transmission paths over the North Pacific the condition of the ionosphere at the time of the announcement, and how communication conditions are expected to be for the following 12 hours.

Forecasts are prepared three times daily by the Bureau's North Pacific Radio Warning Service at Anchorage, Alaska. Currently, only those forecasts issued at 8 A.M. and 4 P.M. (Alaska and Hawaiian time) are relayed to WWVH, Maui, Hawaii.

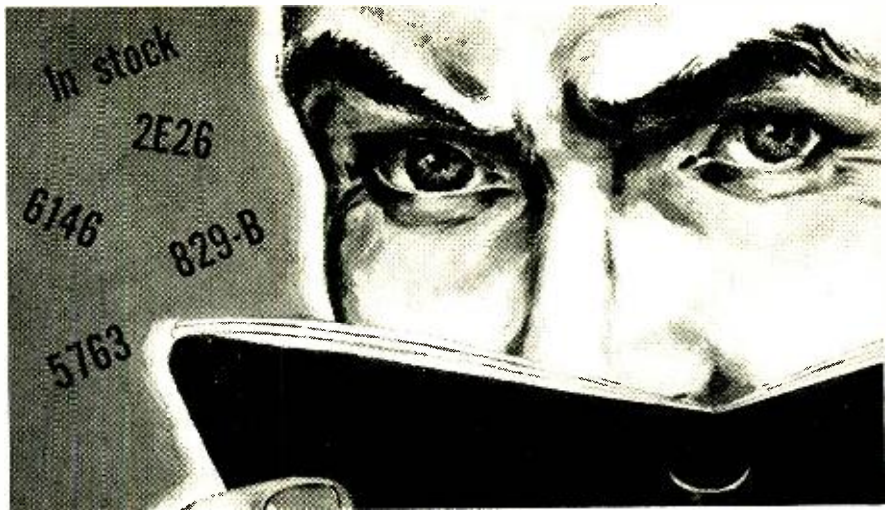

Now forecast your electron tube inventory movement with greater accuracy

IT TAKES FORESIGHT AND GOOD PLANNING on the part of communications men to avoid unbalanced equipment maintenance inventories. This is especially true in the case of operators of fixed and mobile equipment where components such as electron tubes are vital to the continued operation of transmitters and receivers.

Your RCA Tube Distributor can help you to forecast your electron tube requirements with greater accuracy by applying the *RCA Tube Inventory Maintenance Plan* to your specific operation. This plan will help you to reduce overstocks yet maintain a streamlined inventory of tubes at all times.

Not only will you be able to set up accurate reserve stocks under the *RCA Tube Inventory Maintenance Plan*, but your RCA Tube Distributor will be in a better position to back up your requirements with his convenient local supplies, and to service your tube needs with greater efficiency.

There's nothing for you to sign... nothing to buy, to get the plan started. Why not phone your RCA Tube Distributor today. Set up a date to put the *RCA Tube Inventory Maintenance Plan* into operation.

Inventory Control Cards and Visible Record Binder show records of the day-to-day status of each tube type.



RADIO CORPORATION of AMERICA
ELECTRON TUBES
HARRISON, N. J.

NEW LITERATURE

DIRECTIONAL COUPLERS

The relatively new art of microwave directional coupler design is covered in a six-page technical bulletin published by *Airtron, Inc.* Designated as Technical Bulletin T-2400, it provides much of the basic theoretical and design information needed by the engineer in choosing the proper directional coupler for use with reflectometers, test equipment, and power splitters, in local oscillator coupling and similar radar and microwave applications.

Four basic types of directional couplers designed and developed by this manufacturer are also fully described in Technical Bulletin T-2400, copies of which may be obtained without charge by writing to *Airtron, Inc.*, Dept. A, Linden, N. J.

COAXIAL LINES AND WAVE GUIDE

Coaxial transmission lines and wave guide for TV and microwave systems are pictured and described in a 20-page two-color catalog available without charge from *Prodelln Incorporated*, 307 Bergen Ave., Kearny, N. J. Typical tower layouts and bills of material based on actual installations illustrate

the positioning of components and simplify planning and ordering.

TUBE DATA

CBS-Hytron, Danvers, Mass., a division of *Columbia Broadcasting System, Inc.*, has released three pages of data on Type 6X4 tube applications. Prepared by the Panel on Electron Tubes Research and Development Board, New York, N.Y., these data are concerned with the use of Type 6X4 tubes in capacitor-input circuits at a power-supply frequency of 400 cycles. Three charts have been calculated that fulfill criteria for safe operation.

ELECTRON TUBE RELIABILITY

A 97-page report entitled "Investigation of Electron Tube Reliability in Military Applications" has just been published by *Aeronautical Radio, Inc.*, a nonprofit organization currently conducting an extensive study of tube reliability for the Army, Navy and Air Force under a Bureau of Ships contract.

The report covers the period from April, 1951, through March, 1953, and

describes the scope of the *ARINC* surveillance program, methods of tube collection and of engineering and statistical analysis, and the result of the program to date. It is available from L. E. Davis, *Aeronautical Radio, Inc.*, 1523 L St., N. W., Washington, D. C., for 50 cents a copy.

SERVO DEVELOPMENT

Bulletin R-13 comprises a paper entitled "Design Considerations of a Saturating Servomechanism" which was presented by P. E. Kendall and J. F. Marquardt at the National Electronics Conference in September, 1953. This 16-page booklet on servo development may be obtained on request from the *Cook Research Laboratories*, Division of *Cook Electric Company*, 8100 Monticello Ave., Skokie, Ill.

CYLINDRICAL AND ANNULAR COILS

"Magnetic Fields of Cylindrical and Annular Coils," National Bureau of Standards Applied Mathematics Series 38, is available from the Government Printing Office, Washington 25, D.C., for 25 cents a copy. This 29-page publication gives the axial and radial components of the magnetic field—at any point in space—of a cylindrical or an annular coil carrying an electric current. Results are expressed in terms of complete elliptic integrals or Legendre functions which involve ratios of the significant dimensions of the coils.

MEASUREMENT TECHNIQUES

Techniques for making time interval measurements involving high speed clutch systems, relay operating times, and phase delay at very low frequencies are given in Vol. 5, No. 1-2, of the *Hewlett-Packard Journal*. Also contained in this publication are brief details of the new Model 522B electronic counter, together with a list of measurements that the counter will make.

The *Journal* may be obtained by writing to *Hewlett-Packard Company*, 395 Page Mill Rd., Palo Alto, Calif., giving name, business connection and title.

TV STATION FILM MANUAL

A television station film manual, first in an annual series, has been published by the National Association of Radio and Television Broadcasters. Divided into three parts, this 44-page document is available to active television members of NARTB only.

Part 1—"Programming Hours and Costs"—is based on a survey of TV stations, grouped according to the number of TV families in the respective

(Continued on page -47-)

TV-AM-FM SET PRODUCTION

Information based on latest reports from RETMA.

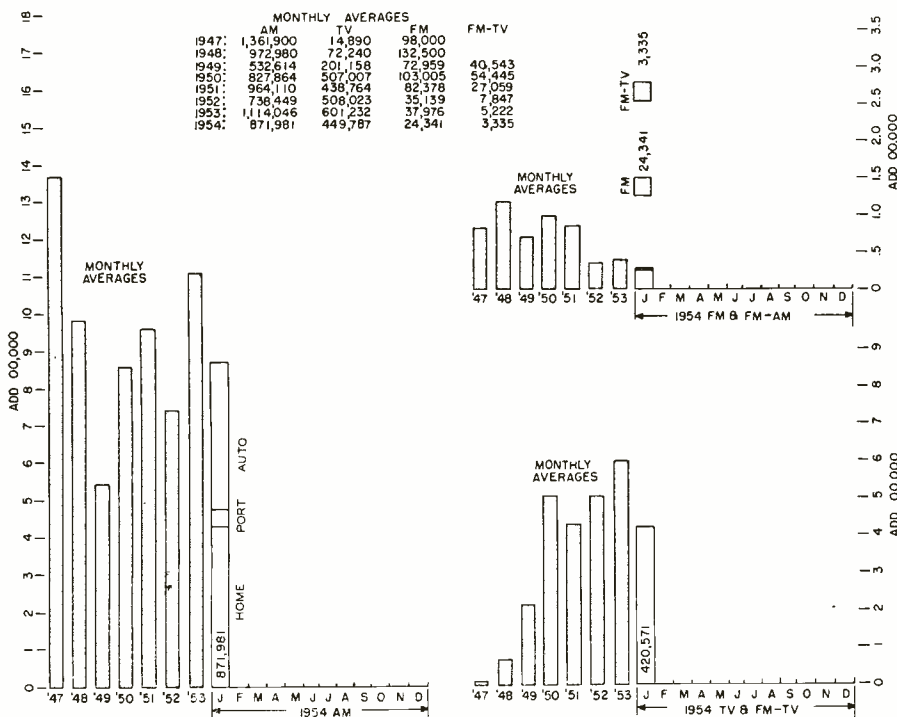

PHILCO ANNOUNCES A REVOLUTIONARY NEW TRANSISTOR

New Diffused Alloy Junction Type Has Amazing Advantages...

Philco now presents to industry a new diffused alloy junction transistor with uniformity of characteristics never before attained in production.

Design engineers will welcome the predictable performance of circuits incorporating this superior transistor.

At last, here is a transistor that will operate with the same high degree of excellence in mass-produced units as in laboratory models—*eliminating the need for individual selection of transistors or associated components to meet equipment specifications!*

Now in production at Philco, this new transistor meets the high standards required for production applications. It is one of the smallest transistors

- Minimum size.
- Hermetically sealed, resistance-welded metal case . . . leads sealed in glass.

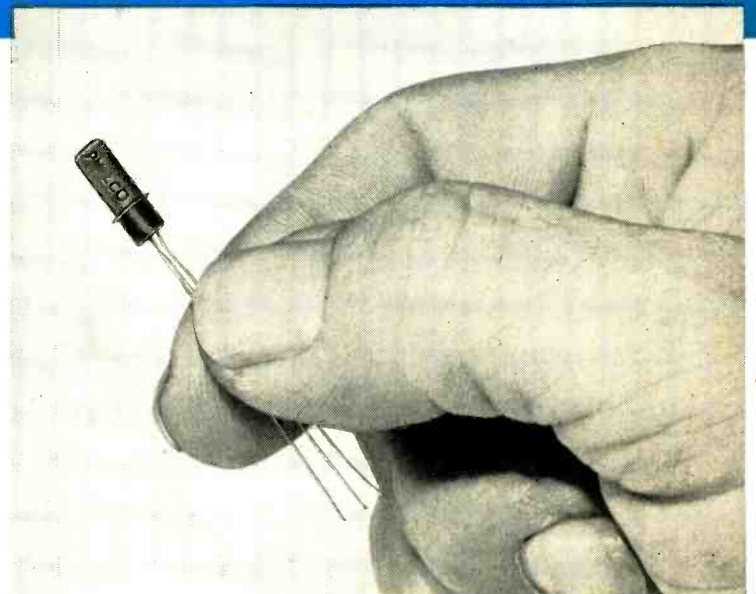

ever produced. Leads are fused in glass—the entire transistor is enclosed in a metal envelope—an instantaneous resistance weld hermetically seals the complete unit. Advanced processing techniques and new mechanical design features assure excellent characteristics and uniformity throughout the life of the transistor. Phone, write or wire Philco today for descriptive literature and specifications on this revolutionary transistor.

- Uniform characteristics.
- Designed to meet typical military environmental conditions.



PHILCO CORPORATION
GOVERNMENT & INDUSTRIAL DIVISION • PHILADELPHIA 44, PA.

Personals

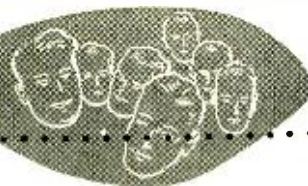

CHARLES T. CARROLL, chief of government engineering at the *Hallicrafters Company*, Chicago, Ill., since 1951, has now been named director of engineering. Mr. Carroll first joined *Hallicrafters* in 1945 as an advanced development engineer; in 1948 he became chief television engineer for *Trav-Ler Radio Corporation*. Prior to 1945, Mr. Carroll was on the engineering staff of *Hazeltine Research Inc.* and spent two years with *Hamilton Radio*.



DR. JAMES B. FISK is the new vice-president in charge of research at *Bell Telephone Laboratories*, New York, N. Y. Since joining the *Laboratories* in 1939, Dr. Fisk has had a distinguished scientific career, including two years as director of research of the Atomic Energy Commission and as Gordon McKay Professor of Applied Physics at Harvard University. In 1949, he was placed in charge of research in physical sciences at the *Laboratories*.



FRANKLIN R. KADISON has been appointed director of research and development at the *Sealtron Corporation*, Cincinnati, Ohio. Having a wide background in developing glass-to-metal products for the electronics industry, Mr. Kadison will apply his experience to *Sealtron's* hermetic seals, bonded compression seals and subassemblies employing these seals. He recently served in the Hermetic Seal Division of *Electrical Industries*, Newark, N. J.



HENRY MAGNUSKI, widely recognized as an authority on long-distance microwave communications systems, has been promoted to associate director of research of *Motorola's* Communications & Electronics Division, Chicago, Ill. Formerly chief engineer of the research department, he will now be technical consultant on all products manufactured by the Division. Mr. Magnuski designed the first 1000-mile private microwave system in the United States.



WILLIAM H. RICKARDS will fill the newly created position of director of engineering at *Ward Products Corporation*, Division of *The Gabriel Company*, Cleveland, Ohio. His duties will consist of establishing the most complete and extensive engineering facilities in the antenna industry. Formerly affiliated with *Radiart Corporation* and *Cleveland Electronics*, Mr. Rickards has spent his most recent years in design and development of TV and automotive antennas.



LEO G. SANDS has been named administrator of railroad communications sales of the Engineering Products Division, *Radio Corporation of America*, Camden, N. J., heading a new activity within the company's communications marketing department. Mr. Sands is a pioneer in the train radio and microwave relay system fields. Prior to joining *RCA*, he was president of the *Bogue Railway Equipment Division* of the *Bogue Electric Manufacturing Company*.

Spurious Frequencies

(Continued from page -16-)

A first thought might be to provide merely enough selection or "sharpness of tuning" in the coils or filter networks following V_2 to eliminate or "tune-out" the 100-kc. sidebands. This would be complicated considerably in the case of an FM or television sound transmitter in that there is also FM modulation on the carrier. Even in the case of phase modulation, the multiplier stages must have a bandwidth at least twice that of the highest audio frequency. For a 15,000-cycle audio tone, a bandpass in excess of 30 kc. would be required. In actual commercial practice, the bandpass must necessarily be much greater in order to achieve low distortion and good high frequency audio response².

For expediency of explanation, assume that a bandpass of 50 kc. is required (not an altogether unreal figure for commercial designs). The tuned bandpass element in the plate circuit of V_2 then has the job of passing 300 kc. without attenuating those frequencies below 275 kc. or above 325 kc. A 50-kc. bandwidth presumes a symmetrical passband of 25 kc. on each side.

In addition, the bandpass element also has the job of rejecting and attenuating by some 40 to 60 db the undesired sidebands of 400 kc. and 200 kc. While a formidable job, it can be done. However, the rejection circuit involves a real bandpass coil design problem which may prove somewhat time-consuming and costly, and may even result in a unit which is difficult to adjust in the field. It is here that the simplified approach illustrated in Fig. 3 can supply real supplementary help with its spurious frequency rejection characteristics.

Slicing off the top and bottom of Fig. 4A, as shown in Fig. 4B, would remove the 100-kc. envelope modulation; in effect, such an action would remove the sidebands. This is the purpose of R_1 in Fig. 3. R_1 serves as the limiting resistor, and the action is the same as in the limiter stage of an FM receiver. The carrier is "wiped" clean of any AM modulation. It is obvious that any of the other commonly used forms of limiting, such as diode clipping, would also accomplish the desired result. However, the resistor often may be preferred in frequency multiplier stages. Such stages are normally driven well into the class "C" high grid current region, providing very effective limiting by the addition of an inexpensive series resistor.

It should be pointed out that the sidebands are of very low amplitude, often of the order of 40 db or more down from the carrier, representing less than 1% "modulation." This might seem to be

an insignificant figure until viewed in the light of present FCC requirements of 60 db or more suppression for all frequencies outside of the assigned frequency bandwidth.

Although the preceding discussion has been confined to circuits using frequency multiplication, the usefulness of the method is by no means limited to such circuits. Practical application has also been found in frequency mixer service for suppression of the undesired frequencies generated by the mixer action. The clipping or limiting, of course, must be in a stage following the mixing. Any attempt to use this type of suppression in any circuit in which amplitude modulation must pass will result in excessive distortion and a large reduction of modulation information energy.

It may be of interest to note that the suppression technique presented here results in some harmonic distortion of the r.f. waveform. However, such distortion may be advantageous, especially in frequency multiplier stages.

When adding this type of suppression to existing circuits, the following precautions should be taken:

1. There must be an excess of r.f. drive available. The clipping or limiting action removes some of the energy which would normally appear on the tube grid.
2. Coils or transformers should be retuned in the associated stage, because the normal grid-to-cathode tube capacity is no longer in pure parallel with the tuning capacitor. The series-limiting resistor serves to reduce the effective grid-to-cathode capacity.
3. It may be necessary to lower the Q of the transformer secondary by means of a high value of parallel resistance. The technique under discussion reduces loading and gives a higher Q , which could increase the hump of an overcoupled circuit to a point where the bandpass characteristic might be impaired.

It would appear that some FM distortion might be introduced since the clipping or limiting action is purposely quite fast. However, in several instances in which the limiting resistor was either built in or added to existing FM equipment, no increase in recovered audio distortion was noted.

In one case where this type of suppression was added to a commercial television transmitter, the spurious sidebands were reduced 25 to 30 db—certainly a worthwhile reduction for the price of a ten-cent resistor. In this particular instance, the sidebands were caused by the crystal frequency, which was in the 200-kc. region, producing sidebands both above and below the sound carrier. Such sidebands are commonly encountered when FM or phase

modulation is accomplished by the now popular pulse techniques'.

Acknowledgment is due Mr. George Oliver of the TV Engineering Department of *Gates Radio Company*. Mr. Oliver did much of the actual testing to substantiate the commercial feasibility of the technique described above.

REFERENCES:

1. Priest, Conan A., Heiden, Charles M., and Pinkerton, David C., "Narrow-band FM Doubles Number of VHF Channels For Mobile Use," *Tele-Tech*, October, 1950.
2. Jaffe, D. L., "Effects of Tuned Circuits upon a Frequency Modulated Signal," *Proc. IRE*, May, 1945.
3. Dishal, Milton, "Alignment of Synchronously Tuned Multiple-Resonant Circuit Filters," *Proc. IRE*, November, 1951.
4. Day, J. R., "Serrasoid FM Modulator," *Electronics*, October, 1948.

Water Loads

(Continued from page -15-)

veloped, and gives up heat to water very readily. On the other hand, glass is difficult to provide with a dielectric constant below 4.0; it is fragile and subject to breakage if not carefully grommited or protected; and glass loads must be carefully designed and made by expert glass blowers in order to avoid subsequent stresses and cracking after prolonged cooling.

Once tooling is provided, plastic water loads are cheap to make. Plastic is a poor conductor of heat in zero flow rate versions, and it has a lower dielectric constant (in most versions ranging from 2.5 to 3.0). However, such loads are very costly to tool up and cannot be repaired or modified, once made. Furthermore, plastic melts, distorts and leaks at high temperatures.

Figure 5 shows a very high power microwave calorimeter with S-, L- and X-band water loads outside their respective wave guides. These particular loads were designed to absorb a maximum of 10,000 watts average or 10 megawatts peak power on the L band, 5000 watts average or 5 megawatts peak power on the S band, and 2500 watts average or 2½ megawatts peak power on the X band. This absorption is accomplished by the use of flow rates up to 4000 cc. per minute. At 10,000 watts average power, such a flow rate causes the water temperature to rise 35°C. Figure 2 shows the reservoir and cooling system designed to handle the calorimeter shown in Fig. 5.

VSWR's of 1.025 to 1.05, readily possible with well designed water loads, correspond to from 99.0 to 99.8% of the incident power being absorbed. This percentage may be easily verified by placing a miniature neon lamp or fluorescent bulb at the end of a wave guide system energized by hundreds of watts of average power. The lamp will cease to light when one-third to two-thirds of the water load is inserted into the wave guide system.

Extra Rugged—Light Weight
HIGH ARTICULATION
E-V
Mobile-Mikes

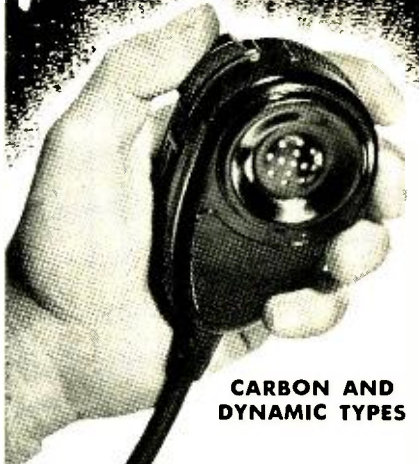

CARBON AND DYNAMIC TYPES

E-V Mobile-Mikes are designed for the ultimate in speech transmission! You get high intelligibility, high output, more usable power level, less listener fatigue and other E-V features. *Proved in toughest service.* Used in public safety, aircraft, railroad and government communications. High impact phenolic case. Permanent finish. Weighs as little as 7 oz. Model 210 Carbon lists at \$28.50. Model 600-D Dynamic lists at \$38.50.

EXACT REPLACEMENT

Carbon Mobile-Mikes also available for exact replacement in current Motorola, RCA, G.E. and similar equipment. You get full advantage of E-V design and performance features.



NOISE-CANCELLING DIFFERENTIAL*



Close-talking, carbon type. Assures clear speech transmission under high ambient noise in any weather or climate. Blast-proof, waterproof, shock-resistant. Model 205 lists at \$38.50. Model 602 Differential Dynamic at \$49.50 list. (*Patent No. 2,350,010)

Send for Bulletin!

Electro-Voice

BUCHANAN, MICHIGAN
Export: 13 E. 40th St., N.Y. 16, U.S.A., Cables: Arlab

AUTHORIZED DISTRIBUTORS EVERYWHERE

Clevite Germanium Diodes

127 TYPES!

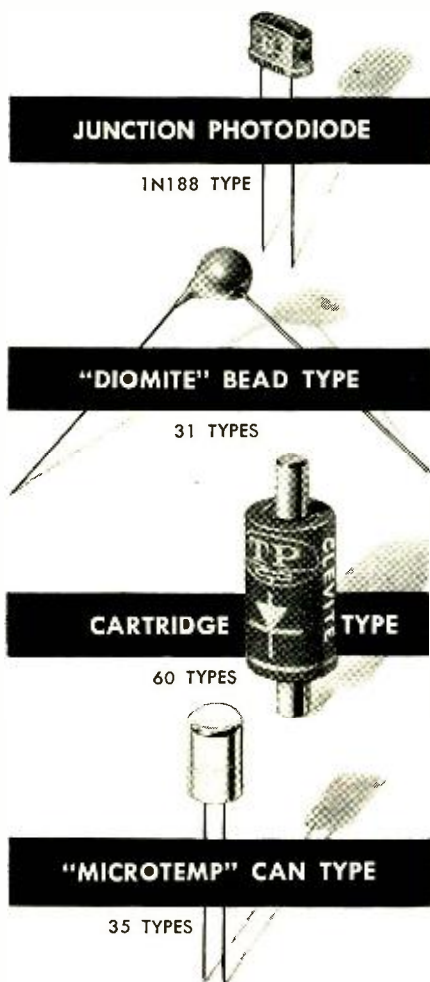

CLEVITE DIODES

offer all these features!

Widest Range of Types available anywhere, Extremely Long Operating Life, Universal Lead Mounting — *at no extra cost*, Positive Electrical Stability, Advanced Hermetic Sealing, Uniformly Low Inter-Electrode Capacitance, Micro-sized, Ruggedly built.

Precision Tested — Low Cost
HUNDREDS OF APPLICATIONS!

As Rectifiers — Detectors — Discriminators — Limiters — Multipliers — Modulators — Switches — and many other new, important uses being discovered daily!

For data sheets and complete information on CLEVITE transistors, diodes and transistor test sets, write Dept. R5.



TRANSISTOR PRODUCTS, INC.

SNOW AND UNION STREETS, BOSTON 35, MASSACHUSETTS
AN OPERATING UNIT OF
CLEVITE CORPORATION

Electrocall

(Continued from page 9-)

sustained to actuate the unit³. After sufficient charge accumulates in C , from the coding signal, the relay is closed by V_{in} . When installed, $B +$ is supplied to the screen of the receiver output tube through the relay. Thus, the receiver output is effectively cut off until the relay is closed but functions normally after the closing. Circuit parameters at V_{in} are such that the relay will remain closed until the momentary contact switch is closed, or until $B +$ is removed upon switching on the associated transmitter.

Sequence of operation is straightforward. The receiver functions normally at all times up to the output tube, which is cut off. When the base transmitter begins a message, it initiates the message with a code pulse. Upon reception of the proper code pulse, the Electrocall receiver unit restores the output to proper functioning, and the receiver operates normally. At the end of the transmission, the receiver is reverted to its usual cutoff condition.

Examination of Figs. 3 and 4 will show that the circuits are essentially the same; slight changes in a few circuit elements (and removal or insertion of the integrating network) will permit either circuit to perform either function. By means of an additional multiple-contact relay, Model 101 Electrocall can perform both coding and decoding functions, providing a simple two-way selective call system.

The design permits exceptional economy of inventory, an essential factor in keeping the final cost low while maintaining high standards of performance. Direct-call, alarm, and control systems can also be devised by minor modifications of the basic unit.

Installation is simple. All connections may be made at one tube in the transmitter or receiver. The station coding unit 102 requires only four connections: two heaters, $B +$ (150-275 volts), and the control grid of the audio input tube. Receiver unit 103 requires five connections—all at the output tube of the receiver: two heaters, $B +$ (120-250 volts), grid 1 and grid 2. The receiver silencing switch is already connected; it may be mounted in any convenient location at the driver's position.

Because more radiotelephone systems are used in taxicab service than in any other commercial field, the use of Electrocall will be described in terms of taxi fleets of varying sizes. Other applications such as police and fire protection fleets would be handled similarly.

How Electrocall Is Used

Problems of radio fleet control of small fleets are quite different from

those of large fleets. In the small fleet of less than 20 vehicles, interference from other nearby fleets is particularly troublesome. As its own base transmitter is on only a small portion of the time, most of the output from the mobile receiver is due to interference. Similarly, with only a few mobile units calling in, most of the output of the dispatcher's receiver is interference which must be endured in order to receive the random calls from its fleet. Since traffic is light, the dispatching is handled by someone who also has other duties—accounting, bookkeeping, etc. Here, the radio chatter has a serious effect on the efficiency with which the dispatcher can perform his other duties. For small fleets, two-way fleet call (Model 101) provides a satisfactory means of controlling chatter and interference. Mobile radios of the fleet are turned on by the base station transmitter, and are silenced at all other times. The central station receiver is turned on only when one of its own fleet is transmitting and is silenced at all other times. Operation of the fleet-call system is automatic, requires least cooperation on the part of either driver or dispatcher, and virtually eliminates interference and chatter in a small fleet.

The situation confronting the operator of a fleet of more than 50 mobile units is quite different. During busy periods, his base station is in almost constant operation, and the mobile receivers are not troubled by reception of signals from interfering stations. However, every receiver in the fleet is in operation almost constantly, with the transmission from the base station coming in at full strength. Since only a very small part of this traffic is of interest to any one cab (with 100 mobile units in the fleet, an average of only 1% would be directed to any one cab), the resulting chatter is of the most annoying kind to the passenger of the cab, and the most tiresome for the driver of the cab. The driver must listen to an average of 100 messages in order to receive one message directed to himself. Naturally, a fleet-call system would be of little benefit in this situation; it would merely eliminate the interference from competing transmitters which exists during slack periods of the day.

For the moderate-sized fleet, a group call system permits rapid dispatching while eliminating most of the chatter over each mobile receiver. To illustrate how Electrocall can be used with a moderate-sized fleet, consider the following example. A fleet of 100 radio-controlled cabs serves a large city, which is divided into five areas for control purposes. A different coding tone is assigned to each area, and by means of a 5-position switch on his dash, each driver can select the tone to which his

radio will respond. When assigned to an area, or upon entering an area, the driver turns his switch to the appropriate position. In directing a message to an area, the dispatcher depresses the corresponding tone selector switch, and the message will be received only by those cabs which are assigned to that area. In this example, the driver must listen to an average of 20 calls in order to receive one directed to himself, instead of 100 as before—a direct reduction in chatter of 80%. In addition, no driver will be annoyed by interference from competing systems, since his radio will be on only when his own base station transmits, and then only when the message is directed to his area. Naturally, there is nothing magic about the number 5; Model 102 will permit up to 10 different groups to be handled with one coding tone per group. Up to 100 groups can be handled by Model 202, which utilizes two coding tones in sequence. Although division of the fleet into groups based upon geographical areas is used in the above example, the essential point is that the fleet be divided into groups; any convenient basis of division may be used.

Fleets involving more than 100 mobile units have many problems not encountered by smaller fleets, chief of which is the limited number of mobile units that one dispatcher can efficiently control. Many schemes have been tried, with varying degrees of success, to cope with the problem. One method by which a group-calling system, in connection with split-channel operation of the radio system and directive antennas, can permit the efficient utilization of several hundred mobile radios in one fleet is illustrated in Fig. 2.

There is no need to go into the principle of confining the coverage of a transmitter to a definite area by means of directive antenna systems using low power radiation. In practical application, the only flaw in such a system is that the radiation from antenna 2 cannot be made to cover sector 2 reliably without putting an appreciable signal inside sector 4. If there is no transmission from antenna 4 into sector 4, then sensitive receivers in sector 4 will also hear messages intended for sector 2, and conversely. (The same interference obtains between sectors 1 and 3.) If, however, the receivers in sector 4 are turned on only when transmitter 4 is transmitting, there will be no interference from sector 2 in sector 4, provided the signal from antenna 4 is moderately greater in sector 4. Such moderate directivity is easy to obtain in practical antenna systems at almost any frequency.

Since the same directivity results from an antenna in receiving as in transmitting, the dispatchers at the base

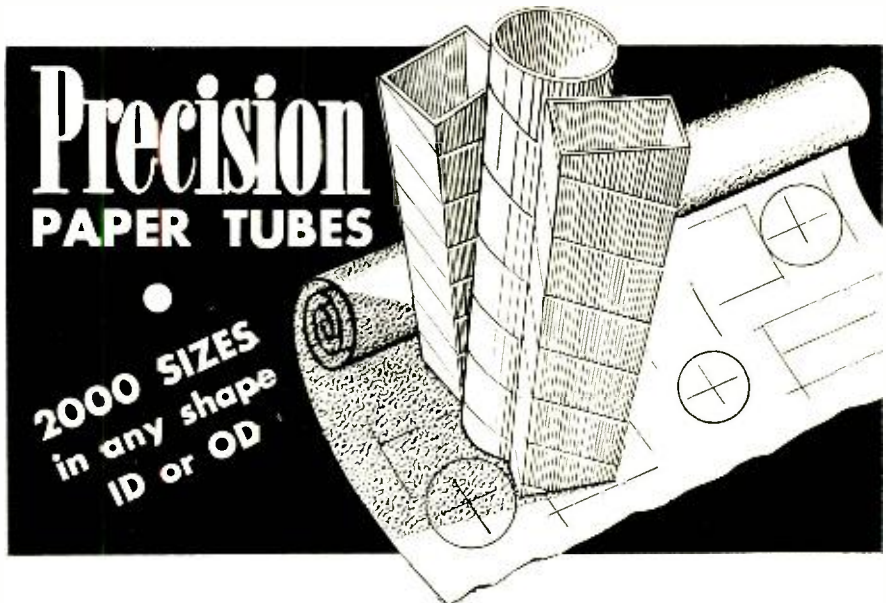

Whatever your specific needs, depend on PRECISION PAPER TUBES to meet all requirements. Spirally wound under pressure, PRECISION PAPER TUBES are subjected to rigid tolerance control to insure strict adherence to specifications and provide maximum winding space. PRECISION PAPER TUBES possess 15 to 20% greater strength, yet are light in weight.

Made from the finest dielectric kraft or fish paper, phenol impregnated, acetate or combinations, PRECISION PAPER TUBES afford high insulation, heat dissipation and moisture resistance. Available in any size, shape, I.D., or O.D.—any quantity.

Write today for Arbor List of over 2000 sizes. . . . Send specifications for free sample.

PRECISION PAPER TUBE CO.

2063 WEST CHARLESTON STREET • CHICAGO 47 • ILLINOIS

Plant No. 2: 79 Chapel St., Hartford, Conn. — Also Mfrs. of PRECISION Coil Bobbins



RESINITE

GIVES YOU THE HIGHEST INSULATION RESISTANCE OF ANY RESINATED PRODUCT

Performance data—compiled from laboratory tests, actual field operations and reports from manufacturers—prove the outstanding operating characteristics of Resinite. In volume resistivity . . . low moisture absorption . . . excellent thermal properties . . . low power factor . . . and resistance to voltage breakdown . . . Resinite outperforms all other resinated products.

Resinite Coil Forms are available with inside or outside threads—slotted, punched or embossed. Special three-row threaded design permits axial pressure in excess of 25 lbs. Torque controllable to + or - 1 inch oz.

Write today for full details and technical information

RESINITE #104
very high dielectric properties under extreme humidity.

RESINITE "AC"
very high dielectric properties—completely immune to electrolytic corrosion.

RESINITE 104
for stapling, severe forming and fabricating.

INSULATION RESISTANCE (READINGS TAKEN UNDER HUMIDITY)

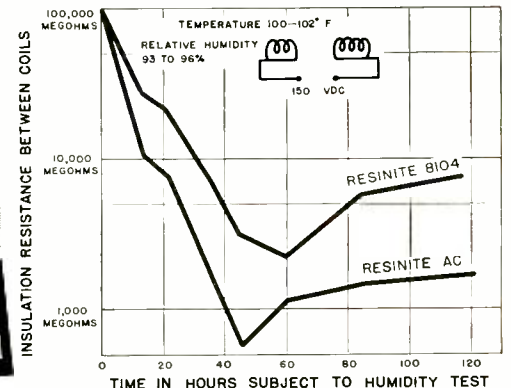

▲ Tests conducted on .253 I.D. x .283 O.D. tubes used on coil forms for television receivers.

RESINITE CORPORATION

DIVISION OF PRECISION PAPER TUBE

2035A West Charleston Street, Chicago 47, Illinois
79 Chapel St., Hartford, Conn.

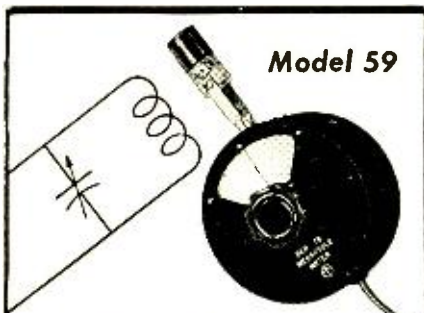

MEGACYCLE METER

2.2 mc. to 400 mc.
Frequency Accuracy $\pm 2\%$

The MULTI-PURPOSE INSTRUMENT

- For determining the resonant frequency of tuned circuits, antennas, transmission lines, by-pass condensers, chokes, coils.
- For measuring capacitance, inductance, Q, mutual inductance.
- For preliminary tracking and alignment of receivers.
- As an auxiliary signal generator; modulated or unmodulated.
- For antenna tuning and transmitter neutralizing, power off.
- For locating parasitic circuits and spurious resonances.
- As a low sensitivity receiver for signal tracing.

And Many Other Applications

FREQUENCY:
2.2 mc. to 400 mc.; seven plug-in coils.

MODULATION:
CW or 120 cycles; or external.

POWER SUPPLY:
110-120 volts, 50-60 cycles; 20 watts.

DIMENSIONS:
Power Unit: 5 1/4" wide, 6 1/4" high; 7 1/2" deep.
Oscillator Unit: 3 3/4" diameter, 2" deep.



Write for Literature

MEASUREMENTS CORPORATION

BOONTON



NEW JERSEY

station can receive independently from each sector with the same freedom from interference—provided the selective calling system is two-way, i.e., provided the mobile transmitters in each sector turn on the associated base station receiver with an appropriate coding pulse. This two-way selective call is available in Electrocall Model 106, which can be supplied to handle up to 10 coding channels.

The foregoing system, using Electrocall units and both halves of split-channel operation coupled with directive antenna systems, will permit the efficient dispatching of almost any sized fleet and will permit the use of more than one dispatcher at peak traffic periods. Peculiarities of terrain or topological layout may require a different type of division of the service area than illustrated, and may require more than two r.f. channels in a particular city, but the principle can be extended to almost any situation.

Conclusion

Electrocall systems are simple, reliable, and low cost means of improving radiotelephone fleet communication in the following ways:

1. Nuisance interference is reduced—the receiver is silenced except when communication is desired. Driver fatigue is greatly reduced.
2. Reliability of communication is increased. When a driver is required to pay attention to all the traffic in a large fleet as well as interference in the same band, it is inevitable that some messages will be missed. With Electrocall, he need hear only pertinent messages. Further, if the driver is out of the cab when a message is directed to him, he now misses that call (and possibly a fare). With Electrocall, when the driver returns to his cab and finds the radio on, he knows that there has been a message during his absence and can call in for a repetition of the message.
3. Passenger comfort is increased. Since the passenger is not harrassed by a bombardment of radio chatter, he is not impelled to ask the driver to turn off the radio.
4. Battery drain is reduced. By effectively cutting off the power tube except when needed, the average power required by the receiver is reduced.

The chatter and interference in police and fire protection service channels are exactly the same as that found in taxi channels; Electrocall can be expected to bring equivalent reduction in chatter to these services. Paging and individual telephone systems can be put on a direct-call basis by Model 202 and 302 units, which can call individually up to 100 and 1000 separate mobile receivers, respectively. These units use the same

operating principles as outlined above for Models 102 and 103.

REFERENCES:

1. Terman, F. E., "Resistance-Stabilized Oscillators." *Electronics*, Vol. 6, July, 1933.
2. Terman, F. E., Buss, R. R., Hewlett, W. R., and Cahill, F. C., "Some Applications of Negative Feedback with Particular Reference to Laboratory Equipment." *Proc. IRE*, Vol. 10, October, 1939.
3. Snow, W. B., "Audible Frequency Ranges of Music, Speech and Noise." *Bell System Tech. Jnl.*, Vol. 10, October, 1931.
4. Valarino, A. R., and Lewinter, S. W., "Radio Dispatching System for a Large Taxicab Fleet." *Electrical Communication*, Vol. 30, No. 1, March, 1953.



Strain Gages

(Continued from page -13-)

it is necessary in order to read absolute values of either static or dynamic loads.

It must be noted that the resistance shunt method of performing calibration of the strain gage system is not practical, as the gage varies its resistance radically with temperature. It could be used if the gage temperature were known and the calibration output corrected with the aid of a graph based on the known change in resistance of the gage with temperature. The resistance change of the gage with temperature would have to be determined empirically. It is important to remember that the coefficient of resistance stated is accurate at ambient temperature only and varies widely throughout the operable temperature range. As Fig. 3 indicates¹, the equivalent strain (fictitious) of various wires used for high temperature strain gages mounted on steel varies radically. A simple but erroneous conclusion could be drawn from this graph—that Karma or Advance (Constantan) wire is the best gage material. Such an assumption, however, does not take into consideration the dL/L effect with other base materials. Thus, in the single-gage installation, the wire which is suitable for aluminum may not be suitable for steel, or vice versa. Securing a wire with lowest resistance-

Table 1. Maximum operating temperatures for gages mounted on various materials.

Material	Recommended Operating Temperature (°F)
Nickel	1800
Inconel or High Nickel Alloys	1800
Ordinary Stainless Steels (such as 18-8)	1000
Common Steels	750
Aluminum and Aluminum Alloys	600

Note: Installation on copper, brass and copper alloys is not recommended

temperature coefficient is not enough. A comparison of both (dR/temp) and ($dL \text{ wire}/dL \text{ metal mount}$) must be made.

Installation Factors

One of the most important aspects of the installation of strain gages is the attachment of the external leads to the gage. Such attachment may not be made with lead-tin soft solders; 50-50, for example, melts at 400° F. Soft solder should not be used at temperatures above 230° F. For work at the highest temperature, 1100° C (2000° F), the electrical leads should be welded to the gage unless the joint itself can be kept away from the base metal or insulated and cooled by air flow. For somewhat lower temperatures, brazing or silver soldering may be employed.

If a single gage is used and it is desired to measure static strains, variations in lead resistance with respect to temperature must be considered. The influence of the leads can be made arbitrarily small by choosing leads of sufficiently low resistance. An alloy of 55% copper and 45% nickel (Constantan) is one of the best lead materials from this standpoint because of its extremely low product of specific resistance and temperature coefficient. This alloy wire may be used at temperatures up to 930° F. An alloy wire of 80% nickel and 20% chromium (Nichrome V) is recommended for applications involving temperatures above 930° F.

Measurement of the strain or stress as produced by the strain gage/s involves simple equations^{2, 3}. The equation to be used for interpreting the output voltage depends upon the installation configuration. The output signal for a single gage is:

$$dE_o = \frac{R_g I K}{2} dS$$

where dE_o is r.m.s. or d.c. volts, I is the gage current (generally one-half the total bridge current), K is the gage factor, and dS is the strain in inches/inch.

A *Trans-Sonic* gage at 3500 microinches/inch strain will produce approximately 9 millivolts output in a single gage installation, at a bridge supply voltage of 5 volts d.c. Multiple gage installations would produce higher values.

When more than one active gage is employed, the formula is almost the same:

$$dS = dE_o \frac{2}{R_g I K N}$$

where N is the number of active gages. With the strain known, the load in pounds may be easily calculated as $P = dS \cdot A \cdot E$, where P is the load in pounds, dS is the strain, A the cross section in inches, and E the modulus of elasticity.

The above equations apply only when all the gages under strain are mounted axially with the load or strain direction. Where dummy gages are not on an auxiliary plate, but are cemented on the stressed structure at right angles to the axial stress, the bridge output will be higher than indicated by the equation by a factor of μ or 2μ , where μ is the designation for Poisson's ratio. Poisson's ratio indicates the ratio of lateral strain to a given axial strain. The lateral strain, produced at right angles to the axial load (by that load) is approximately 0.25 and 0.33, respectively, for steel and aluminum alloys. For a half-bridge (with the dummy on the structure), the correct factor is $dE_o (1 + \mu)$; while for the full mounted bridge (two active, two dummy), it is $dE_o (1 + 2\mu)$.

A gage should never be mounted on a plated metal because of the differences in strain between the two metals. In cases where the base metal is plated, it is good practice to remove a section of the plating and bond the gage to the base metal.

REFERENCES:

1. AGARD Rome Conference Report Memo # AG 2/M1.
2. Kaufman, A. B., "Oscillographic Strain Gage Recording," *Radio-Electronic Engineering*, September, 1950.
3. Kaufman, A. B., "Stress and Strain Determination," *Radio-Electronic Engineering*, November, 1950.

Worth planning for!

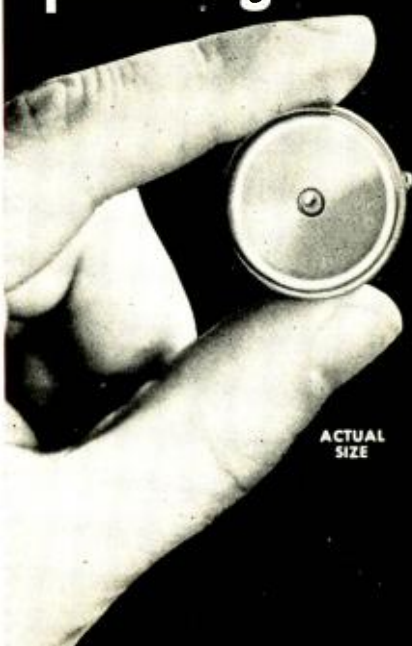

ACTUAL
SIZE

new SHURE series of 1-inch "Controlled Reluctance" Microphones

These Rugged Microphones Make Ideal Components for Small, Compact Equipment

• The new Shure MC Series of 1-Inch "Controlled Reluctance" Microphones were specially designed for use with transistor circuits—and they are highly recommended for use in transistor-type hearing aids. These 1-Inch Microphones are also ideally suited for use in vacuum tube devices such as small, compact Amplifiers, Transmitters, Dictating Equipment—wherever size and weight are factors, and portability is extremely important. The MC Series Microphones normally are furnished with impedance of 1000 ohms (other impedances are available).

The MC Series Microphones are rugged magnetic units, relatively immune to mechanical shock and to varying conditions of heat and humidity.

For technical information Write,
Wire or Call Sales Division

SHURE BROTHERS
 INCORPORATED
 225 West Huron Street
 Chicago 10, Illinois

Professional Directory

GEORGE P. ADAIR Engineering Co.

Consulting Engineers

Radio, Television, Communications,
Electronics

1610 Eye St., N.W. EXecutive 3-1230
Washington 6, D. C.



SINCE
1931

Professional 16mm Sound-On-Film Motion
Picture Cameras for Television Newsreels,
Commercials and other Television Filming.

Write for free illustrated catalog.

BERNDT-BACH, Inc.
7349 Beverly Blvd., Los Angeles 36, Calif.

GABRIEL ELECTRONICS DIVISION

Formerly Workshop Assoc. Div.
THE GABRIEL COMPANY



Specialists in
High-Frequency
Antennas

Endicott St. Norwood, Mass.
NORwood 7-3300

Paul W. Klipsch
Professional Engineer
Acoustic development
and consulting

Klipsch and Associates
building the authentic
KLIPSCHORN
world's finest sound reproducer

Hope, Arkansas Tel. Hope PRespect 7-3395

FRANK H. McINTOSH

Consulting Radio Engineer

1216 Wyatt Bldg., Washington 5, D. C.
MEtropolitan 8-4477
Member AFCCE

MEASUREMENTS CORPORATION



Research &
Manufacturing
Engineers

Harry W. Houck John M. Van Beuren M. A. Honnell
Specialists in the Design and
Development of Electronic Test Instruments
BOONTON, N. J.

New Products

(Continued from page -24-)

kmc.; and Type No. 68051, for 26.5 to 40.0 kmc. Additional information may be obtained without charge by writing to *Airtron, Inc.*, Dept. A., Linden, N. J.

AUTOMATIC WAVE ANALYZER

Completely automatic reduction of vibration, seismic, power line transient, noise, shock, and similar data by Fourier analysis can be made on the new heterodyne-type Series 901 *Davies* automatic wave analyzer. It consists of six basic units which are available individually as well as in an assembly: input switching panel, oscillator-controller, modulator-filter, recorder, power supplies, and rack.

Suited for operation from any source supplying a repetitive signal, such as a magnetic tape loop, this wave analyzer covers the frequency range of 3 to 2000 cps. Features include: a variable bandwidth of 1/2 to 45 cps, analysis down to 3 cps, amplitude accuracy of $\pm 5\%$ of reading on the logarithmic scale, a frequency accuracy 1/2% of reading, input voltage range of 60 db, and input impedance of 2 1/2 megohms. Complete details are given in *Davies* Bulletin 54-C, which may be obtained by writing to *The Davies Laboratories Incorporated*, 4705 Queensbury Rd., Riverdale, Md.

COLOR TV SCANNER

Engineers at the Communications and Electronics Division of *Motorola*,

AIRCRAFT SELECTIVE CALLING EQUIPMENT

GROUND-TO-AIR radio transmissions to preselected individual aircraft can be made with a tone-coded selective signaling system called Airborne "Quik-Call." Known generically in the aircraft industry as SELCAL, this equipment was developed by the Communications and Electronics Division of *Motorola, Inc.*, Chicago, Ill., and is reportedly the first of its type to receive CAA type certification.

Such an alerting system relieves the pilot or radio operator of the responsibility of maintaining a continuous listening watch on the aircraft's radio channels and completely eliminates the effects of nuisance noise. The "Quik-Call" device does not disrupt normal receiver reception but allows the headset to be removed or the loudspeaker to be switched off until a call signal is received.

Each aircraft is equipped with a selective signaling decoder for each radio channel which must be monitored for an alerting signal. The ground-located base station transmitting to aircraft is equipped with a tone code selector and code generating unit. To call a specific plane, a tone code is selected and transmitted by the dispatcher. Upon reception, this tone code activates a light or bell notifying the airborne radio operator that a call is intended for him.

Only the selected aircraft is alerted. Receiver alarms in other similarly equipped aircraft do not respond even though tuned to the same radio frequency. Non-equipped receivers monitoring the channel hear only an instantaneous tone pulse.

Vibrasenders, extremely stable mechanical oscillators (or tuning forks), control the frequency of the electronic tone generating circuits. When the button on the selector panel is pressed, two coded pulses, each containing two discrete tones, are transmitted sequentially. These tones—received in the aircraft's receiver—are fed to a decoder unit containing companion Vibrasenders, essentially resonant reed relays, which respond only to specific tones. Upon receipt of the proper tone combination, a relay is energized to actuate either an audible or visible alert alarm. A total of over 1400 individual codes can be created from 12 basic tones without duplication or without tone combinations conducive to false operation.

This equipment has been under development for almost two years, and for the past year has been subjected to more than 500 hours of strenuous flight condition testing and simulated operation on *Pan American World Airways* Pacific air routes.

Decoder unit located aboard Pan American World Airways clipper.

Ground dispatcher's selector panel for "Quik-Call" selective calling system.

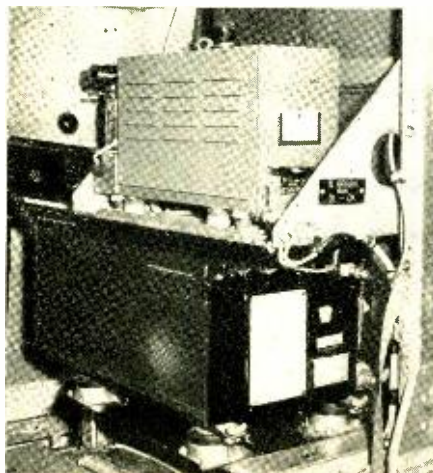

Inc., 4545 W. Augusta Blvd., Chicago, Ill., have developed a film scanner for color TV projection. An all-electronic device which employs a synchronized flying spot scanner as a light source, it will permit high quality projection of TV programs from 16-mm. color films. The all-electronic technique makes possible continuous film motion with corresponding minimum film wear.

A servo-control system for positioning the scanning light source in syn-

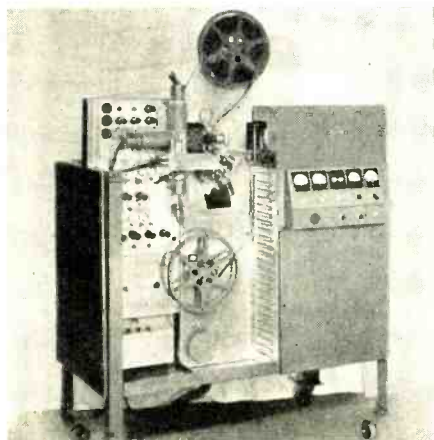

chronism with film motion provides complete picture stabilization and automatic correction for film shrinkage. Because of the absence of moving optical parts in the light path, full opening of the projector lens aperture is possible, resulting in a higher quality reproduction than previously available.

DIGITAL DIFFERENTIAL ANALYZER

Simplicity of operation and unusual mathematical versatility characterize the high speed, moderately priced electronic computer which has been announced by *Bendix Computer Division of Bendix Aviation Corporation*. A digital differential analyzer, the computer utilizes the decimal numbering system in both programing and in calculating solutions.

The fundamental operation of the machine consists of numerical integration of any variable with respect to any other variable, linear or nonlinear, which generates a third variable. Integrators may also be coded to perform addition, multiplication, division, comparison, limiting, decision, and servo operations. The computer has a capacity of 60 integrators.

An illustrated brochure giving complete information on this digital differential analyzer can be secured by writing to *Bendix Computer Division*, 5630 Arbor Vitae St., Los Angeles 45, Calif.

CROSSBAR SWITCH

The new *Kellogg* crossbar switch furnishes a fast, economical means of in-

terconnecting or selecting many different circuits common to large-scale complex switching required in automatic control systems or computers. Mounted for drawerlike removal from its rack, the unit incorporates palladium contact points and can provide any circuit connection in approximately 50 milliseconds by the energizing of two specific coils. Its modular-like construction affords many of the interconnections which must be made separately in relay trees, etc.

This switch is capable of many applications, such as connecting any three of 60 circuits to any 75, or choosing one circuit from as many as 936 circuits. Further information may be ob-

tained by writing to the Industrial Department of *Kellogg Switchboard and Supply Company*, 79 W. Monroe St., Chicago 3, Ill.

INTERVALOMETER

Abrams Instrument Corporation has announced an intervalometer available in two models (B-9A and B-10A), and an auxiliary count limiter (CN-1A1) for use with the intervalometer. For complete information on both units, write to the *Abrams Instrument Corporation*, Dept. S6, 606 E. Shiawassee St., Lansing 1, Mich.

The intervalometer (left) was designed to furnish a 28-volt d.c., 3-

CORNELL-DUBILIER

and *Faradon*

The universally
recognized
standard
in MICA
transmitter
capacitors.



Cornell-Dubilier Electric Corp., So. Plainfield, N. J.

There are more C-D capacitors in use today than any other make
See your classified telephone directory for name
and address of nearest C-D authorized distributor



CONSISTENTLY DEPENDABLE
CORNELL-DUBILIER
CAPACITORS

PLANTS IN SO. PLAINFIELD, N. J., NEW BEDFORD, WORCESTER AND CAMBRIDGE, MASS.

PROVIDENCE, R. I., INDIANAPOLIS, IND., SANFORD AND FURQUAY SPRINGS, N. C. SUBSIDIARY: RADIANT CORP., CLEVELAND, OHIO

ampere inductive pulse of .250-second duration at regular time intervals. Time interval between successive pulses may be changed instantly by turning a

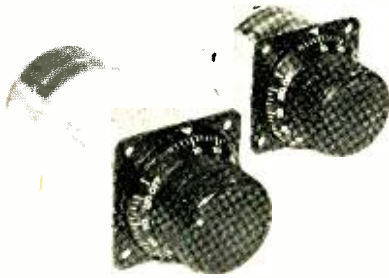

dial; repeat accuracy of the pulse interval is within ± 10 milliseconds over a supply voltage range of 24 to 29 volts, d.c. The auxiliary instrument (right) may be used as a pulse counter and limiter for stopping the intervalometer at the desired number of pulses from 1 to 120 as set on its dial.

TAPE RESISTORS

Stable tape resistors are now being offered by *Sanders Associates, Inc.*, 137 Canal St., Nashua, N. H., for a wide range of printed circuit applications. They are available either as cured, ready-to-use resistors only $\frac{1}{2}$ " long, $\frac{1}{8}$ " wide and $1/100$ " thick, or as uncut, uncured tape rolls.

Both types have a resistance range of 100 ohms to 10 megohms, and conform to all JAN-R-11 specifications. They are suitable for semiautomatic applications in which a single operation, requiring less than one second, fastens them permanently to the chassis and connects them into the circuit.

IMPEDANCE-MATCHED SWITCH

Input power may be diverted to either of two output channels in the

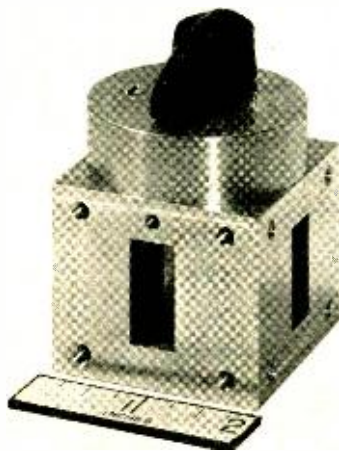

broadband impedance-matched switch announced by *General Precision Laboratory*, 63 Bedford Rd., Pleasantville, N. Y. It is a compact, lightweight,

manually operated switch for X band in RG-52/U wave guide size, available in aluminum or brass construction. Maximum VSWR in switched positions is 1.10 over the 8500 to 9600 mc. band, and isolation between output channels is nominally 30 db.

SPECTRUM ANALYZER

Model TSA is a portable all-band spectrum analyzer which covers the range of 10 to 22,000 mc. with three interchangeable r.f. heads. Announced by *Polarad Electronics Corporation*, it is a compact unit, approximately the same size as a conventional wide-band oscilloscope, yet incorporating all features necessary for efficient analysis.

A single-dial, direct-reading, r.f. tuning control allows quick and simple

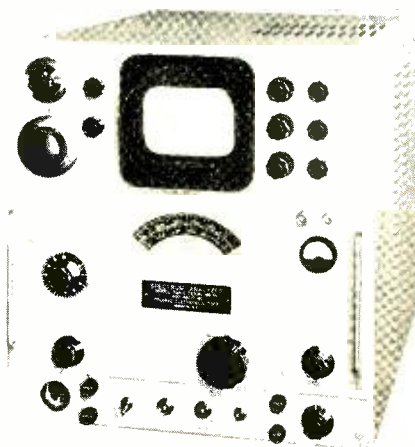

selection of any frequency spectrum, and a swept i.f. yields constant dispersion characteristics completely independent of frequency setting. Frequency dispersion from 250 kc. to 25 mc. may be realized with a resolution of 25 kc. For further information on the Model TSA, write to *Polarad Electronics Corporation*, 100 Metropolitan Ave., Brooklyn 11, N. Y.

INDUCTION HEATING UNIT

Now being offered by *Lindberg Engineering Company* for soldering, brazing and light heat-treating applications is the Model LI-5A-1, a redesigned 5-kw. output high-frequency induction heating unit. The basic redesign incorporates a heavier sheet steel cabinet for rugged industrial use—insuring minimum r.f. radiation—and fully complies with FCC regulations.

Lindberg's exclusive "Checklite" system of indicating lamps has been relocated to the cabinet front for easier observation and convenience, and the temperature-controlled water cooling system has been redesigned to reduce water consumption and to eliminate any possibility of moisture condensation on internal components and work coils. For additional details, write for

Bulletin No. 1440, available from *Lindberg Engineering Company*, 2450 W. Hubbard St., Chicago 12, Ill.

Protective Relaying

(Continued from page -11-)

sensitive to impedance changes of the line. In this system, carrier is employed as a blocking element for external faults. Owing to the sensitivity of impedance relays, faults existing in other interconnected lines appear as faults in the protected section, and will cause the breakers to trip. Directional relays (relays sensitive to the direction of current flow) start carrier transmission. Carrier is received at remote and local ends, energizing a relay which holds open the trip circuit.

Protective relaying is of such importance that a fail-proof installation is required. Carrier equipment is operated on 125- or 250-volt battery supplies. Long-life tubes are employed, and daily checks are made to insure that equipment is in operating order. Provisions are available for initiating the carrier and measuring its received level at the far end. Tripping of the circuit breakers is prevented in this instance because a fault detector relay has not

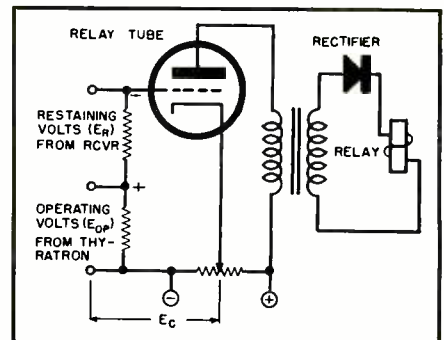
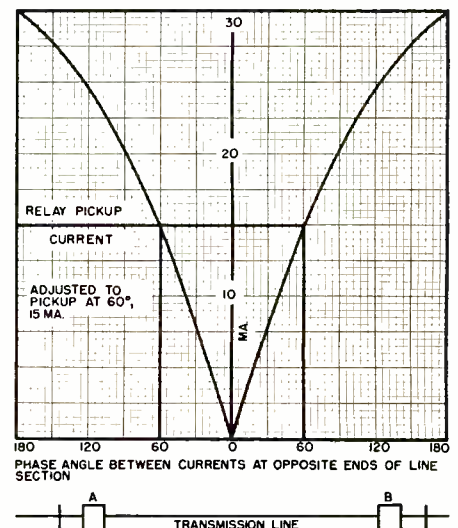

Fig. 6. Simplified schematic diagram of the relay tube circuit.

Fig. 7. Operating range of tripping relay in relay tube circuit.



been energized by the output from the sequence filter.

In the initial installation of the carrier equipment, r.f. levels are carefully noted. This is accomplished by measuring the receiver detector current. Attention is also paid to weather conditions since an increase in the attenuation, with a consequent decrease in received signal, occurs during adverse weather conditions. If the receiver level is below the defined limit, the carrier set is immediately serviced. When equipment is protected in this manner, carrier failures are rarely experienced.

Optical-Sensing Device

(Continued from page -20-)

tronic unit generates scanning voltages which drive the cathode-ray tube beam, and receives in return the photocell signals from the scanning assembly. Answer information is fed into the output cabinet, where it is converted into coded-pulse form suitable for recording on eight-channel magnetic tape. Power is supplied to all these units from the fourth cabinet.

FOSDIC's electronic equipment is composed of many separate and distinct circuit groups, each designed to carry out a unique function. For example, the index recognition circuit determines when the scanning beam is at the top edge of a solid mark between 0.24" and 0.36" high. To make this decision, however, it must previously have been informed that a number of other conditions have been met. Among these conditions are: (1) a frame to be scanned must be present, (2) the degree of tilt of the document must have been measured, (3) the scanning beam must be over the page, and (4) the apparent index mark must be genuine and not a thin vertical line crossed obliquely by the scanning beam. The reading program begins immediately after recognition of the index mark occurs.

All information is read out in serial order in blocks of 720 characters and occupies four of the eight channels on the magnetic tape. A character consists of four digits; thus, each block can contain more than 2800 digits. Each document—either single- or double-sided—is included in one block, and the remainder of the 720 characters is made up of dummy pulses. To assure that the order is not upset by the loss of a column somewhere on the page, FOSDIC makes a column count on each document. If a column is missed for any reason, such as a film defect, a characteristic record is made on the tape informing the computer that information in this block is not trustworthy. Information contained on such documents is then restored to the tape by a supplementary correction process.

Transistor Characteristics

(Continued from page -18-)

2. Assuming that V_B is very much greater than V_{EB} , the value of I_k should be calculated from Eq. (4).
3. A "load line" should be drawn on the collector characteristic with $(E_{CC} - V_B)$ as the voltage intercept at $I_C = 0$ and with R_C as the slope.
4. Intersection of the load line of step 3 with the emitter current curve determined in step 2 yields I_C —solution of Eq. 5.
5. V_{FB} now may be found from the emitter characteristic, knowing I_k and I_C .
6. Steps 2 through 5 must then be repeated using this value of V_{FB} . Because V_{FB} is generally much smaller than V_B , a single correction generally is sufficient.
7. I_B now may be computed from Eq. (6), with I_k and I_C known.

As an illustrative example, the *Western Electric A-1768* will be used again. For this circuit, $R_C = 4600$ ohms, $R_E = 1550$ ohms, and $E_{CC} = -22.5$ volts. The seven enumerated steps, together with the characteristic of Fig. 2, allow the preparation of Table 2. Results of Table 2 are plotted



Specifically Designed For
Rugged Mobile Communications Service

DEPENDABLE
and Trouble-Free
VIBRATORS



Select your replacement vibrators wisely... and you, too, will choose Radiart! Laboratory tests and customer reports prove that Radiart Vibrators give LONGER LIFE and trouble-free performance BECAUSE THEY ARE BUILT TO WITHSTAND RUGGED SERVICE! These extra hours of dependable performance is one of the factors that has made Radiart the leader. Superior engineering and design have made them THE STANDARD OF COMPARISON.

At all good radio parts jobbers. Ask for the new Form F781 listing the latest replacement recommendations.



IT'S RIGHT WHEN IT'S RADIART

THE **RADIART** CORPORATION
CLEVELAND 13, OHIO

• VIBRATORS • AUTO AERIALS
• ROTORS • TV ANTENNAS • POWER SUPPLIES



in Fig. 6, together with experimental extremes and the theoretical curve obtained when only the collector characteristic is used.

Again, the completely accurate graphical result lies within the extremes of the measured data. The errors incurred by neglecting the emitter characteristic are relatively small for the usual application. Since neglecting V_{EB} eliminates the trial-and-error aspect of the analysis of this circuit, use of the emitter characteristic should be made only when extreme accuracy is desired.

Grounded-Collector Connection

Pertinent equations for the grounded-collector circuit shown in Fig. 1C are:

$$E_{EE} = V_{EB} + I_V (R_V + R_B) + I_C R_B \quad (7)$$

$$V_C = V_{CB} + (I_C + I_E) R_B \quad (8)$$

The graphical solution for V_C vs. I_C may be obtained by the following five-step procedure:

1. Value of collector current I_C should be chosen.
2. A "load line" should be drawn on the emitter characteristic with $(E_{EE} - I_C R_B)$ as the voltage intercept at $I_E = 0$ and with $(R_E + R_B)$ as the slope.
3. Intersection of this load line with

the collector current of step 1 yields V_{EB} and I_E —solution of Eq. (7).

4. Given I_C and I_E , the voltage V_{CB} may be found from the collector characteristic.

5. Equation (8) now may be solved for V_C .

It will usually be found that $I_E (R_B + R_E)$ is very much larger than V_{EB} , since $V_{EB} = I_E R_B$. In this case, the graphical solution of steps 3 and 4 may be omitted, as:

$$I_V \approx \frac{E_{EE} - I_C R_B}{R_B + R_E} \quad (9)$$

Obviously, this eliminates the need for the emitter characteristic.

It is more difficult to achieve accuracy in the graphical analysis of this circuit, since step 4 requires interpolation on the characteristic curves in their most nonlinear region. Unless a collector characteristic with very small emitter current increments is available, the graphical method for the grounded-collector connection tends to be more difficult and less accurate than for the two other basic connections.

Since the results have been tabulated and plotted for the two other basic circuits, they will be omitted here. The correlation between the graphical and measured results is only a function of whether or not typical units are tested,

assuming great care is taken with the analysis.

Conclusions

Graphical analysis of transistor circuits is as useful and realistic as the similar analysis of vacuum-tube circuits. It is not necessary to ignore the fact that the transistor is a basically nonlinear device.

The proper approach to transistor circuit synthesis is by a design around its average characteristics. This design should be prepared to function properly over the widest possible fluctuation of parameters, as is normal in any design procedure. The measurement of parameters for each unit, and the tailoring of the circuit to fit, obviously cannot be tolerated in practical application.

It is to be hoped that transistor manufacturers will become more sympathetic with this point of view, so that they will provide the potential users of the device with complete characteristic curves based upon extensive measurements.

REFERENCES:

1. Anderson, A. E., "Transistors in Switching Circuits," *Proceedings of the I.R.E.*, November, 1952, pp. 1541-1558.
2. Anderson, A. E., "Some Switching Aspects of Transistors," *The Transistor*, Bell Telephone Laboratories, 1951, pp. 283-333.
3. Trent, R. L., "Idealized Negative Resistance Characteristics of the Transistor," *The Transistor*, Bell Telephone Laboratories, 1951, pp. 249-281.

ZOPHAR

WAXES COMPOUNDS

Zophar waxes, resins and compounds to impregnate, dip, seal, embed, or pot, electronic and electrical equipment or components of all types; radio, television, etc.

Cold flows from 100°F. to 285°F.

Special waxes non-cracking at -76°F.

Compounds meeting Government specifications, plain or fungus resistant.

Let us help you with your engineering problems.



ZOPHAR MILLS, INC.

112-130 26th Street,
Brooklyn 32, N. Y.

I_E (ma.)	$E_{CC} - I_E R_B$ (volts)	I_C (ma.)	$(I_E + I_C) R_B$ (volts)	V_{EB} (volts)	V_C (volts)
0.00	-22.5	-1.35	-2.70	-0.05	-2.75
0.50	-23.5	-2.80	-4.60	0.1	-4.50
1.00	-24.5	-4.20	-6.40	0.2	-6.20
1.25	-25.5	-5.20	-7.40	0.2	-7.20
1.75	-26.0	-5.55	-7.60	0.2	-7.40
2.00	-26.5	-5.85	-7.50	0.2	-7.50
2.25	-27.0	-6.10	-7.70	0.25	-7.45
2.50	-27.5	-6.35	-7.70	0.3	-7.40
3.00	-28.5	-6.80	-7.50	0.35	-7.25
3.50	-29.5	-7.05	-7.10	0.35	-6.75
4.00	-30.5	-7.30	-6.60	0.35	-6.25
5.00	-32.5	-7.80	-5.60	0.40	-5.20
6.00	-34.5	-8.30	-4.60	0.45	-4.15
7.00	-36.5	-8.80	-3.60	0.50	-3.10

Table 1. Graphical analysis of the grounded-base emitter characteristic of Western Electric A-1768 transistor with $R_B = R_C = 2000$ ohms and $E_{CC} = -22.5$ volts.

Table 2. Graphical analysis of grounded-emitter base characteristic of Type A-1768 transistor with $R_C = 4600$ ohms, $R_E = 1550$ ohms, and $E_{CC} = -22.5$ volts.

V_B (volts)	$E_{CC} - V_B$ (volts)	V_{EB} (volts)	I_E (ma.)	I_C (ma.)	I_B (ma.)
-6.00	-16.5	0.45	3.58	-3.50	-0.08
-5.00	-17.5	0.42	2.96	-3.70	0.74
-4.00	-18.5	0.37	2.34	-3.90	1.56
-3.00	-19.5	0.30	1.74	-4.05	2.31
-2.50	-20.0	0.24	1.45	-4.05	2.57
-2.00	-20.5	0.22	1.15	-3.85	2.70
-1.75	-20.75	0.20	1.00	-3.70	2.70
-1.50	-21.0	0.18	0.85	-3.50	2.65
-1.00	-21.5	0.13	0.56	-2.85	2.29
-0.75	-21.75	0.11	0.41	-2.45	2.04
-0.50	-22.0	0.09	0.27	-2.05	1.78
-0.25	-22.25	0.00	0.16	-1.70	1.54
0.00	-22.5	-0.05	0.03	-1.40	1.37
1.00	-23.5	-0.05	0.00	-1.40	1.40



TRANSISTORS

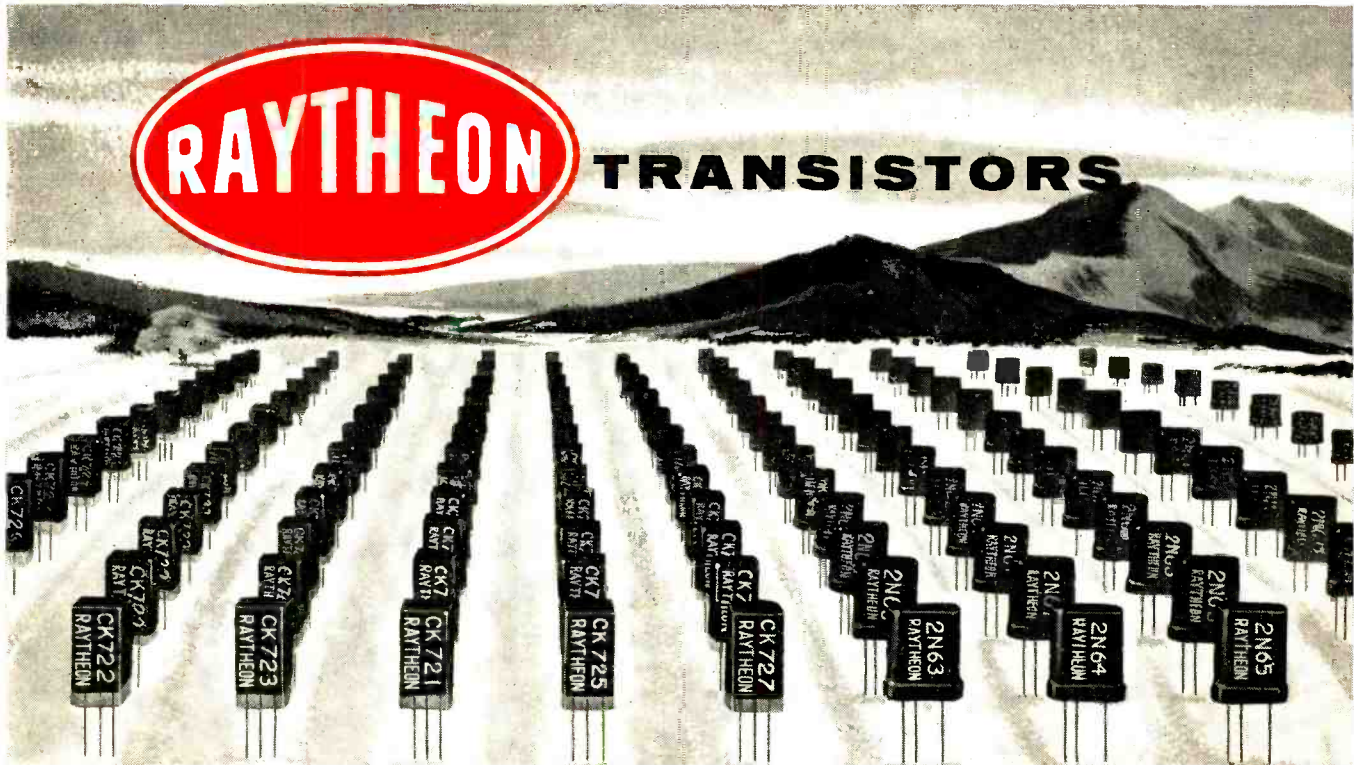

Foremost in the field

RAYTHEON TRANSISTORS are **FOREMOST IN THE FIELD** with **PROVEN RELIABILITY**. Over **1,000,000,000 OPERATING HOURS** of actual field performance in commercial equipment with only a **FRACTION OF 1% FIELD RETURNS** proves their reliability to be superior to the reliability of vacuum tubes.

RAYTHEON TRANSISTORS are foremost in number of units in use in commercial equipment. Raytheon successfully made transistors in "experimental," "pilot" and now **MASS PRODUCTION** phases. The latest continuous, mass production, and inspection techniques are employed in the making of Raytheon Transistors. **HUNDREDS OF THOUSANDS** are **IN ACTUAL COMMERCIAL USE** — **MANY TIMES MORE THAN ALL OTHER MAKES COMBINED**. No other manufacturers can make these statements.

RAYTHEON GERMANIUM DIFFUSED JUNCTION PNP TRANSISTORS

RATINGS: — ABSOLUTE MAXIMUM VALUES:	CK722	CK723	CK721	CK725	CK727	2N63*	2N64*	2N65*
Collector Voltage (volts)	-22	-22	-22	-22	-6	-22	-22	-22
Collector Current (ma)	10	10	10	10	10	10	10	10
Collector Dissipation (30°C) (mw)	33	33	33	33	30	33	33	33
Emitter Current (ma)	10	10	10	10	10	10	10	10
Ambient Temperature (°C)	50	50	50	50	50	50	50	50
AVERAGE CHARACTERISTICS (27° C)								
Collector Voltage (volts)	-6	-6	-6	-6	-1.5	-6	-6	-6
Emitter Current (ma)	1	1	1	1	0.5	1	1	1
Collector Resistance (meg)	2.0	2.0	2.0	2.0	2.0	2.0	2.0	2.0
Emitter Resistance (ohms)	25	25	25	25	50	25	25	25
Base Resistance (ohms)	250	350	700	1500	500	350	700	1500
Base Current Amplification Factor	12	22	45	90	35	22	45	90
Cutoff Current (approx.) (ua)	6	6	6	6	6	6	6	6
Noise Factor (max) (db)**	30†	25†	22†	20†	12†	25†	22†	20†

*Hermetically sealed in metal package
 **In a one cycle band width at 1000 cycles

†Measured at $V_c = -2.5$ volts in common emitter circuit
 ††Measured at $V_c = -1.5$ volts; $I_c = 0.5$ ma in common emitter circuit



Excellence in Electronics

RAYTHEON MANUFACTURING COMPANY

Receiving Tube Division — Home Office: 55 Chapel St., Newton 58, Mass.

For Application Information Call: Boston, Bigelow 4-7500 • Chicago, National 2-2770 • New York, Whitehall 3-4980 • Los Angeles, Richmond 7-4321

RAYTHEON MAKES ALL THESE:

RELIABLE SUBMINIATURE AND MINIATURE TUBES • SEMICONDUCTOR DIODES AND TRANSISTORS • NUCLEONIC TUBES • MICROWAVE TUBES • RECEIVING AND PICTURE TUBES

Sweeping Technique

(Continued from page 7-)

Equipment Requirements

The author has found that some auxiliary equipment is essential to permit full utilization of the wide-band sweep. In addition to the sweep generator and oscilloscope, a number of other devices are required to permit all the different measurements and tests to be made:

1. *Marker*—This may be supplied in the form of a single-frequency r.f. signal from a u.h.f. signal generator, or a cavity absorption-type marker can be used.
2. *Detector*—As a 50Ω coaxial detector, a type UG-119/U fitting using a 1N21B crystal diode is recommended. 300Ω and 600Ω balanced-type detectors are also required and can either be designed or purchased.
3. *Fixed Attenuator*—A number of coaxial and 300Ω balanced attenuator pads should be available. Preferred values are 3 db, 6 db, 10 db, and 20 db.
4. *Long Line*—35 to 50 feet of RG-55/U or RG-5/U coaxial cable can be coiled up and used in this condition. For 300Ω measurements, a similar length of 300Ω u.h.f. twin lead line should be used, mounted on a larger single loop properly insulated from any ground.
5. *Termination*—Any commercially available coaxial 50Ω termination and a 300Ω balanced termination can be used. A 300Ω balanced termination can be designed or purchased from various sources.
6. *50 to 300Ω Balun*—This device has been advertised and described in recent literature. The balun should have a VSWR of better than 1.2:1

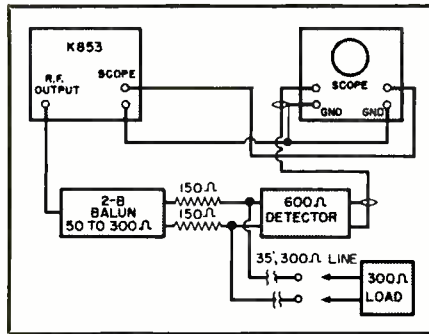

Fig. 7. Block diagram of test setup for VSWR measurements on 300-ohm line.

over the band. Balance-to-unbalance ratio of such a balun should be at least 30 db or better.

7. *Oscilloscope Pre-amplifier*—Several test equipment manufacturers supply preamplifiers suitable for the wide-band sweeping technique.

Conclusion

The technique of sweeping at a high repetition rate for u.h.f. development described in this article is a powerful tool for the research and design engineer working in the u.h.f. spectrum. Visual presentation of such characteristics as bandwidth, VSWR or attenuation permits both adjustment and observation of the effects of this adjustment, thus saving time and making alignment considerably more efficient.

Measurements and tests discussed here form only the skeleton of this technique. Many more test setups and diverse applications are possible and will undoubtedly be used by researchers in the field. The author has recently developed a system which permits multiple simultaneous displays of various characteristics by means of electronic switching. Another application of electronic switching to extend the frequency range uses two or more sweep generators for adjacent frequency bands and superimposes the total spectrum on a single oscilloscope presentation; this permits observation, for example, of the entire response of a high-pass filter as used in the input of many TV tuners. Still another development is the use of circular or spiral sweep to present the frequency

response over an extremely wide band in a single oscilloscope picture.

Although, in this article, the wide-band sweeping technique has been described for use in the u.h.f. band only, it has also been successfully employed in the microwave region for other projects. The power of instantaneous visual presentation of measured characteristics is such that filter design and tests which normally would require many months have been completed by the wide-band sweep technique in a few weeks.

New Tubes

(Continued from page 26-)

nized version) are electrostatic-focus tubes; they contain the new Westinghouse FM-44 gun which is capable of producing a sharper picture despite an increased deflection angle of 90°. The 21AMP4 and 21AMP4A (aluminized) are magnetic-focus tubes. For further information, write Westinghouse Electronic Tube Division, Dept. T-028, Box 284, Elmira, N. Y.

GERMANIUM DIODES

Hermetically sealed ceramic germanium diodes are being produced at the germanium products plant of the General Electric Company at Clyde, N. Y. Three JAN types (1N69, 1N70 and 1N81) and some commercial computer types are now available in production

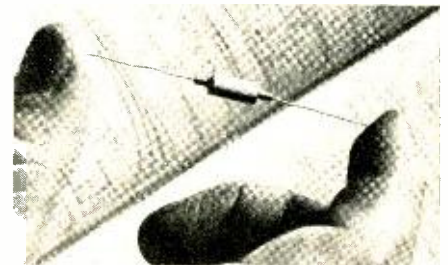

quantities, and other commercial types will be available shortly.

All features of G-E's plastic case diodes have been preserved in the new hermetically sealed units, which are the result of several years of research and development. The hermetic seal is metal-to-ceramic; gas-tight ceramic

CALENDAR of Coming Events

MAY 3-6—Spring Technical Meeting of U.S.A. National Committee of the International Scientific Radio Union and IRE Professional Group on Antennas and Propagation, National Bureau of Standards, Washington, D. C.

MAY 4-6—RETMA Electronic Components Symposium, Washington, D.C.

MAY 7-8—New England Radio Engineering Meeting (NEREM), Sheraton Plaza Hotel, Boston, Mass.

MAY 10-12—National Conference on Airborne Electronics, Dayton Biltmore Hotel, Dayton, Ohio.

MAY 24-26—National Telemetering Conference, Hotel Morrison, Chicago, Ill.

MAY 25-27—NARTB Broadcast Engineering Conference, Palmer House, Chicago, Ill.

INDEX OF ADVERTISERS

NAME	PAGE	NAME	PAGE
Adair Engineering Co., George P.	-40-	McIntosh, Frank H.	-40-
Berndt-Bach, Inc.	-10-	Measurements Corporation	-38-, -40-
Carter Motor Co.	-47-	Philco Corporation	-33-
Connecticut Telephone & Electric Corp.	-3-	Precision Paper Tube Co.	-37-
Cornell-Dubilier Electric Corp.	-41-	Radiart Corporation, The	-43-
Eitel-McCullough, Inc.	-19-	Radio Corporation of America	-21-, -27-, -29-, -31-
Electro-Voice	-35-	Raytheon Manufacturing Company	-45-
Federal Telephone & Radio Company	-4-	Resinite Corporation	-37-
Freed Transformer Co., Inc.	Fourth Cover	Shure Brothers, Inc.	-39-
Gabriel Company, The	-40-	Transistor Products, Inc.	-36-
Klipsch & Associates	-40-	United Transformer Co.	Second Cover
Knights Company, The James	-28-	Westinghouse Electric Corporation	-23-
Link Radio Corporation	-25-	Zophar Mills, Inc.	-44-

cases with metalized ends permit solder seal to nickel pins.

HIGH VACUUM RECTIFIER

The Los Gatos Brand 3B24W is a thoriated-tungsten type of high vacuum rectifier. With full-filament connection, operation is 5 volts at 3.0 amperes; with a half-filament connection, operation is 2.5 volts at 3.0 amperes. Average plate characteristics for this ruggedized half-wave rectifier in both types of operation are shown graphically in a new data sheet available from *Lewis and Kaufman, Ltd.*, 70 El Rancho Ave., Los Gatos, Calif., which also illustrates the tube and provides outline dimensions.

New Literature

(Continued from page -32-)

areas of the stations; Part II—"Case Histories"—details the film policies and operational procedures of six individual stations; and Part III—"Station Comments"—represents the comments of telecasters on the "Do's and Don'ts" of film practices.

PULSE-FORMING NETWORKS

Pulse capacitor and pulse network design and production facilities are described in a two-page bulletin issued by *Corson Electric Mfg. Corp.*, 540 39th St., Union City, N. J. The single sheet, which also illustrates typical *Corson* units and contains ordering information, is available to all interested parties.

HYBRID JUNCTIONS

Special design features of short slot hybrid junctions for high frequency radar and communications are presented in a two-page bulletin available from *Microwave Development Laboratories, Inc.*, 220 Grove St., Waltham 54, Mass. Electrical and physical characteristics of these hybrid junctions are also included in Bulletin HJ-1, and several applications are illustrated and described.

TIC REPORT

Laboratory Report No. 8, featuring a method of measuring phase shift through a computing magnetic amplifier

PHOTO CREDITS

PAGE	CREDIT
-5-	Kollsman Instrument Co.
-8-, -9-	Lectrolab Mfg. Co.
-12-	Trans-Sonics, Inc.
-14-, -15-	Sightmaster of Calif Co.
-20-	Nat. Bureau of Standards

using the Type 7000-A primary phase standard, is available upon request from *Technology Instrument Corporation*, 531 Main St., Acton, Mass. Also included in this four-page publication is a discussion of the measurement of small angles in the vicinity of 0° with the Type 320-AB phase meter.

ELECTROMAGNETIC RELAYS

Virtually all factors pertinent to the design, manufacture and use of relays are covered in a brochure published by *Potter & Brumfield*. Entitled "Symposium on Electro-Magnetic Relays," it contains selected papers from a two-day symposium given on this subject at Oklahoma A & M College, Stillwater, Okla., and is available without charge from the Advertising Department of *Potter & Brumfield*, Princeton, Ind. Represented among the contributors are relay manufacturers, equipment manufacturers and government personnel.

POWER SUPPLIES

Allied Engineering Division of Allied International, Inc., Connecticut & Richard Aves., South Norwalk, Conn., offers an eight-page, three-color catalog on power supplies for voltage regulation. Five standard models in the company's line are presented, including

a miniature unit. Clear illustrations and conservative, factual engineering specifications are given for each type of supply.

Communication Review

(Continued from page -22-)

two stock racing cars during a recent 160-mile Grand National race at Daytona Beach, Fla. Lap position, track

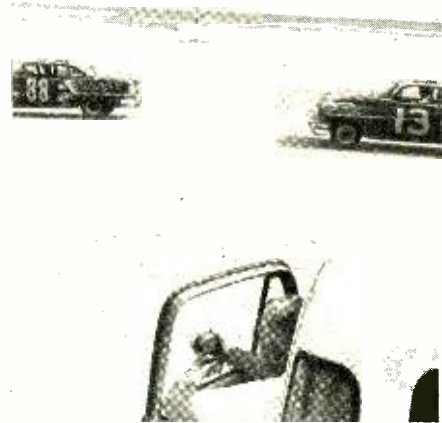

conditions and gas-supply information could be relayed between attendants in the pit and the drivers. The racing cars, both owned by Ernest Woods, of Richmond, Va., finished first and eighth, respectively, in a field of 60 cars.

NEW Carter SLIDE CHART

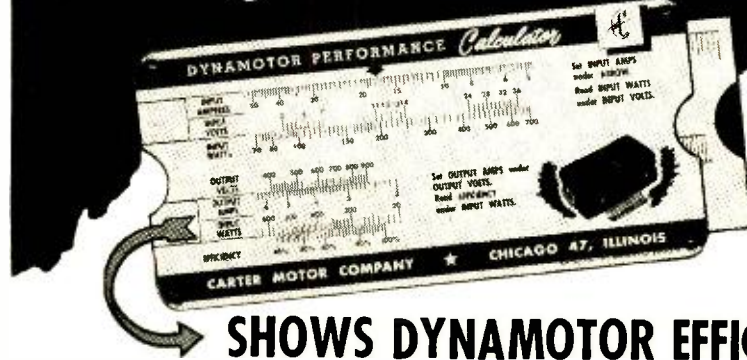

SHOWS DYNAMOTOR EFFICIENCY

25c at a Glance!

AT YOUR RADIO PARTS
DISTRIBUTOR OR
ELECTRONIC EQUIPMENT
SUPPLIER

WRITE for FREE
**DYNAMOTOR
CATALOG**

Now it's easy to compare Dynamotor performance efficiency under actual operating conditions. Nameplate information plus this simple slide chart enables you to read instantly the efficiency percentage right from the Calculator scale. Reverse side gives other useful information. Handy 3" x 6" pocket size, color printed on sturdy laminated stock, varnished to resist soil. For sale by radio parts distributors and electronic equipment suppliers, or 25c postpaid.

Carter Motor Co.

2641 N. MAPLEWOOD AVE. CHICAGO

World's largest Exclusive Manufacturers of mobile radio

FREEED Instruments & Transformers

Famous For

QUALITY • DEPENDABILITY • ACCURACY

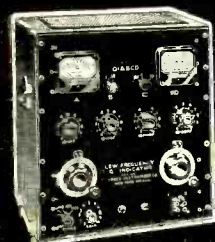

No. 1033
Low Frequency
'Q' Indicator



No. 10208
Megohmmeter



Decade
Inductors



No. 1040
Vacuum Tube Voltmeter



No. 1210
Null Detector &
Vacuum Tube Voltmeter



No. 1010
Comparison Bridge



No. 1110A
Incremental Inductance
Bridge

FREEED MINIATURE AUDIO TRANSFORMERS

PROFESSIONAL MINIATURE AUDIO TRANSFORMERS

These high quality, miniature transformers feature hermetic sealing for maximum protection from moisture penetration with subsequent electrolysis and corrosion of fine wires. While primarily intended for non-military equipment, these units are constructed in accordance with MIL-T-27 Specifications.

CATALOG NO.	APPLICATION	IMPEDANCE LEVEL OF ME		MAXIMUM POWER LEVEL V.U.*	MAX PRI DC PEF SIDE RATIO	D.C. UNBAL. Ma.	REQ. RE-SPONSE C.P.S.	CASE NUMBER
		PRIMARY	SECONDARY					
PMA 1	Line or microphone to single or push-pull grids	50/200/500	60,000 C.T.	+8	1:1	0	±2.0 DB 30-20000	DM-12
PMA 2	Dynamic microphone or speaker voice coil to single or P.P. grid	4/8	60,000 C.T.	+8	1:1	0	±2.0 DB 30-20000	DM-12
PMA 3	Line or microphone to single or push-pull grids; Magnetically shielded.	50/200/500	60,000 C.T.	+8	1:1	0	±2.0 DB 30-20000	DM-12
PMA 4	Single triode plate to single or push-pull grids	15,000	60,000 C.T.	+8	1:2	0	±2 DB 30-10000	DM-12
PMA 5	Single triode plate to push-pull grids	15,000	60,000 C.T.	+8	1:2	2	±2 DB 20C-10000	DM-12
PMA 6	Single triode plate to multiple line	15,000	5C/200/500	+8	5.1:1	0	±2 DB 30-20000	DM-12
PMA 7	Single triode plate to multiple line	15,000	5C/200/500	+8	5.1:1	2	±1 DB 20C-10000	DM-12
PMA 8	Push-pull triode plates to multiple line	30,000 C.T.	5C/200/500	+8	7.7:1	2	±2 DB 30-20000	DM-12
PMA 9	Crystal mike or pickup to multiple line	60,000	5C/200/500	+8	11:1	0	±2 DB 30-20000	DM-12
PMA 10	Mixing or matching	50/200	50/200/500	+8	1:1.50	0	±2 DB 30-20000	DM-12
PMA 11	Parallel Feed Reactor * 1 mw. reference level.	40 HZ	3 ma ac,	3500 ohms D.C. resistance				DM-12

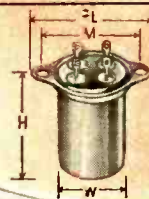

DM-12 CASE DIMENSIONS

FL - 1 1/2
FD - 1 1/32
W - 15/16
H - 1 15/32
M - 1 7/32

Screws - 4-40
Cut out - 7/8
Wgt. - 1.5oz.

Send for complete catalog on
Freeed Instruments and Transformers

FREEED TRANSFORMER CO., INC.

100 ST. (RIDGEWOOD) BROOKLYN 27, N.Y.